



LAMILUX Lichtkuppel F100

Montageanleitung

LAMILUX Rooflight F100

Assembly instruction

Allgemeines

General remarks

Deutsch:

Der Inhalt der Montageanleitung wurde nach bestem Wissen erstellt.
Alle Hinweise, technischen und bildlichen Angaben entsprechen dem derzeitigen technischen Stand, sowie unseren darauf basierenden Erfahrungen.

Rechtliche Ansprüche können daraus nicht abgeleitet werden.
LAMILUX behält sich Änderungen der technischen Angaben vor.

Alle Arbeiten sind nach den anerkannten Regeln der Technik, den Vorschriften und Richtlinien von Behörden, Berufsgenossenschaften, Unfallverhütungsvorschriften und Fachverbänden der Bundesrepublik Deutschland, der Europäischen Union und des Bestimmungslandes auszuführen. Soweit Normen, Regeln der Technik oder Richtlinien (beispielsweise EN, DIN, VDE, VDI, VDS oder ihnen gleichzusetzende Normen) bestehen, so ist unter Einhaltung dieser zu arbeiten.

Revisionsindex:
Diese Ausgabe ersetzt vorhergehende Ausgaben komplett.

English:

The content of this mounting instruction has been established to the best of our knowledge.
All notes, technical and visual information reflect the current state of technology and are based on our experiences.

Legal claims cannot be derived from the content of this installation manual.
LAMILUX reserves the right to change technical specifications.

Every work has to be done in accordance with the current state of technology, the regulations and guidelines of authorities, trade associations, accident prevention regulations and professional associations of the Federal Republic of Germany, the European Union and the country of destination. As far as standards, technical regulations or guidelines (e.g. EN, DIN, VDE, VDI, VDS or equal standards) exist, the work has to be done in compliance with those directives.

Revision index:
This version replaces previous editions completely.



Die Betriebsanleitung ist zu beachten
Insbesondere Sicherheits- und Bedienungshinweise

*The instruction manual must be observed
Especially safety and operating instructions*



Kunststoffkuppeln dürfen nicht betreten werden DURCHBRUCHGEFAHR

Do not step on rooflights - RISK OF BREAKING THROUGH



Immer absturzsichernde Maßnahmen vornehmen

Always use fall arrest equipment and follow national regulations for fall-through protection



Vollständigkeit der Lieferung gemäß Ladestückliste prüfen

Check if the delivery is complete (according to the bill of materials)

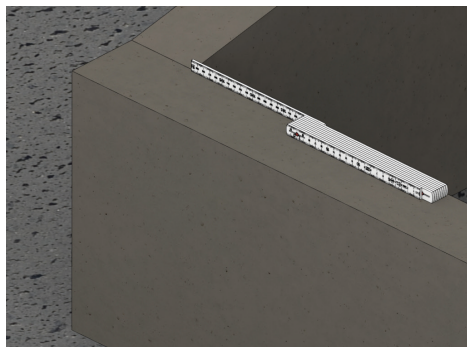

Prüfung der Rohbausituation

Im Allgemeinen gelten die Baukörper toleranzen welche auf unserer Homepage zum Downloaden zur Verfügung stehen.

(www.lamilux.de/downloads)

Check and prepare for mounting and installation

In general, the building tolerances apply which can be found on our homepage.

(www.lamilux.de/downloads)

Inhaltsverzeichnis

Table of Contents

Diese Montageanleitung ist nach der Reihenfolge der Montageschritte aufgebaut.
This installation manual is structured according to the sequence of assembly steps.

| | |
|--|---------|
| Transport Montage <i>transport assembly</i> | 6 - 7 |
| Bauanschluss <i>structural attachment</i> | 8 - 9 |
| Lüftbar verriegelt (Blattfederverschluss) <i>ventilated locked (laminated spring lock)</i> | 10 - 11 |
| Starr verschraubt (Z-Blech) <i>rigidly bolted (Z sheet)</i> | 12 - 13 |
| Zahnstangen-Antrieb Typ "ZA" <i>rack and pinion drive type "ZA"</i> | 14 - 15 |
| Teleskop-Spindelantrieb (Handspindel) <i>telescope spindle drive (hand spindle)</i> | 16 - 17 |
| Pneumatikzylinder <i>pneumatic cylinder</i> | 18 - 19 |
| Pneumatikzylinder mit Rohrklemmanschluss <i>pneumatic cylinder with pipe clamp connection</i> | 20 - 21 |
| 230V Motor Typ "JMBB" <i>230V drive type "JMBB"</i> | 22 - 23 |

| | |
|---|---------|
| 24V Motor Typ "JM-DC" <i>24V drive type "JM-DC"</i> | 24 - 25 |
| Kettenschubmotor Typ "KSA" <i>chain drive type "KSA"</i> | 26 - 27 |
| Kettenschubmotor Typ "Ne-Ka" <i>chain drive type "Ne-Ka"</i> | 28 - 29 |
| Kettenschubmotor Typ "Windowmaster" <i>chain drive type "Windowmaster"</i> | 30 - 31 |
| Anschlusspläne Elektromotoren <i>wiring diagrams of electric drives</i> | 32 - 34 |
| Kontakte <i>contacts</i> | 35 |

Transport | Montage

Transport | assembly

Lichtkuppelenelemente werden in der Regel komplett vormontiert auf ihrem Aufsatzkranz angeliefert. Das Gesamtelement ist auf einer Holzpalette befestigt.

Rooflights are usually delivered completely pre-assembled on its upstand. The overall element is mounted on a wooden pallet.

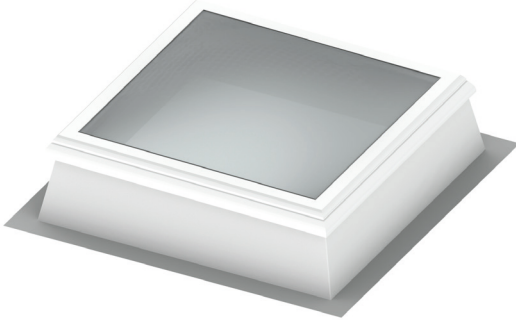

Bei getrenntem Transport von Oberteil und Aufsatzkranz müssen die Lichtkuppeloberteile nach Montage des Aufsatzkranzes eingesetzt werden.

If upper part and upstand are transported separately, the upper part of the element needs to be mounted after installation of the upstand.

Bolzenscharnier
bolt hinge

>> Oberteil
upper part
#312618

>> Unterteil
lower part
#312619

>> Messingbolzen
brass bolt
#312620

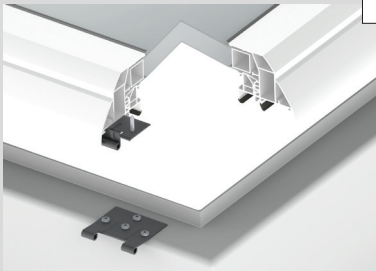

1

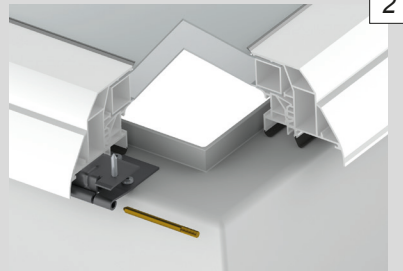

2

Einclipblech
clip sheet
#216596

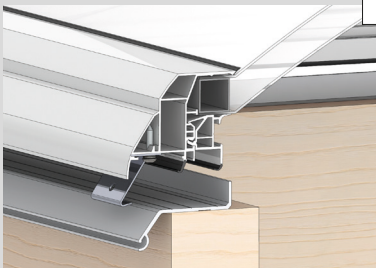

1

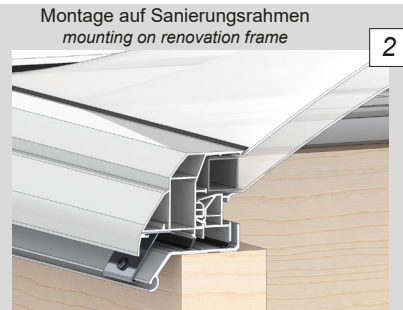

2

Beim Transport entweder über die Palette anheben, oder das Element ohne Palette über z.B. Kanthölzer an den markierten Eckpunkten des Rahmens anheben.

During transport, either lift the element using a pallet or without a pallet, e.g. using square timbers to lift the element on the marked corner points of the frame.



!! ACHTUNG !!

Lichtkuppelteile durchlüftet auf Holzbalken ablegen.
Nicht flach auf der Dachbahn ablegen.
Verformungsgefahr



!! ATTENTION !!

*Place the rooflight on wooden beams that the element can aerate.
Do not place the element flat on the roof membrane.
Risk of deformation*



HITZESTAU VERMEIDEN!
Avoid heat accumulation!

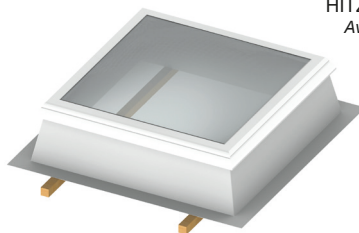

!! ACHTUNG !!

Lichtkuppeloberteil nicht mit der Kunststoffverglasung auf der Dachbahn ablegen.
Verformungsgefahr

!! ATTENTION !!

*Do not place the upper part of the rooflight with its plastic glazing on the roof membrane.
Risk of deformation*

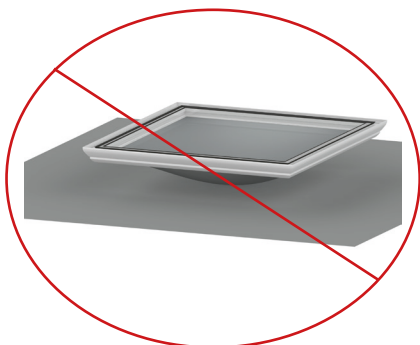

Bauanschluss

Structural attachment

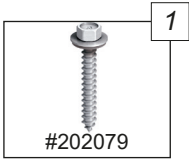

1
#202079
Holzschraube
JA3-6,5x50-E16/2
Wood screw
JA3-6,5x50-E16/2

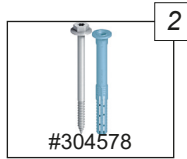

2
#304578
Schraubdübel
SDF-KB-10Vx50-V
Screw-in wall plug
SDF-KB-10Vx50-V

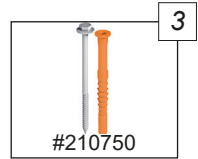

3
#210750
Schraubdübel
SDP-KB-10Gx80-V
Screw-in wall plug
SDP-KB-10Gx80-V

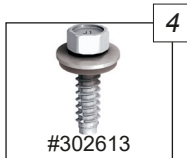

4
#302613
Dichtschraube
JA3-6,5x32-E16/2
Sealing screw
JA3-6,5x32-E16/2

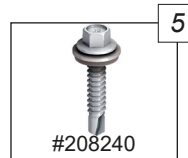

5
#208240
Bohrschraube
JT3-6-5,5x30 E16/2
Drilling screw
JT3-6-5,5x30 E16/2

| Unterkonstruktion <i>Substructure</i> | Positionsnummer <i>Item number</i> | Bohrung im Kranz <i>Drill hole in upstand</i> |
|--|---------------------------------------|--|
| Holzbohle <i>Plank</i> | 1 | Ø 7mm |
| Stahlbeton <i>Reinforced concrete</i> | 2 | Ø 10,5mm |
| Porenbeton <i>Aerated concrete</i> | 3 | Ø 10,5mm |
| Stahl <i>Steel 0,63 - 1,5mm</i> | 4 | Ø 7mm |
| Stahl <i>Steel 1,5 - 3mm</i> | 5 | Ø 6mm |



Befestigungsmittel gehören nicht zum Lieferumfang.
Gleichwertige Alternativen mit bauaufsichtlicher Zulassung sind verwendbar.

*Fastening material is not included in scope of delivery.
Equivalent fasteners with technical approval could also be used.*

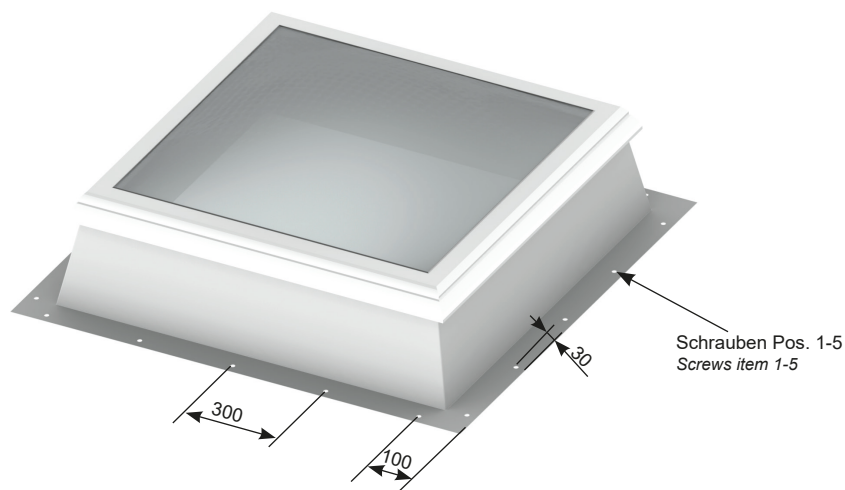

Zur Befestigung der Klemmprofile am Aufsatzkranz keine Schrauben verwenden, sondern spritzwasserdichte Spezialnieten.

Bei Kunststoffbahnen: Presslaschenblindniet mit Neoprenscheibe 5,2x19,1 Al/Al (#216043)

Bei Bitumenschweißbahnen: Presslaschenblindniet mit Neoprenscheibe 5,2x28,6 Al/Al (#216044)

Do not use screws to fasten the clamping profiles to the upstand, instead use splash-proof special rivets.

For plastic sheeting: Press plate blind rivet with neoprene disk 5.2x19.1 Al/Al (#216043)

For bituminous welding sheeting: press plate blind rivet with neoprene disc 5.2x28.6 Al/Al (#216044)

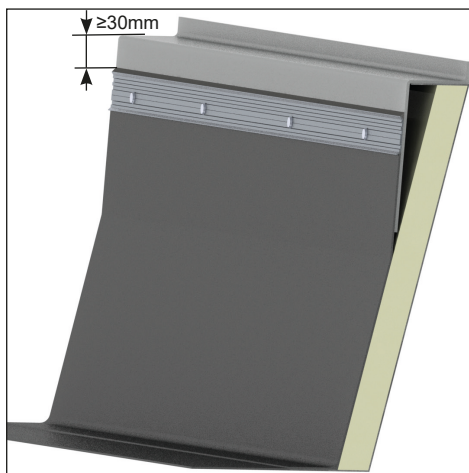
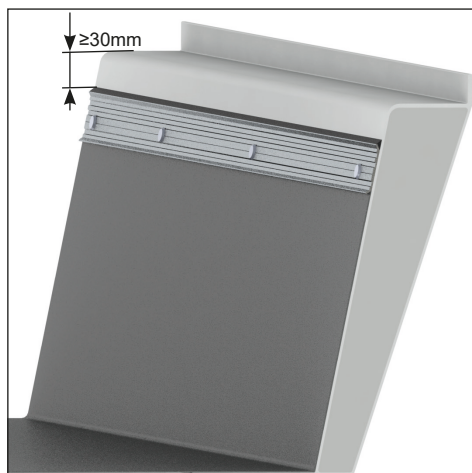

Unser gezeichneter Anschluss dient lediglich der Prinzipdarstellung zur Orientierung!

Die Fachregeln für Dächer mit Abdichtungen, z.B. Flachdachrichtlinien, sind bei der Planung und Ausführung der Dachabdichtungsarbeiten durch das Dachdeckungsunternehmen einzuhalten!

The drawn connection only serves as a schematic for orientation!

The roofing specialist must comply with technical standards for waterproofed roofs, such as flat roof guidelines, when planning and carrying out roof sealing work!

Lüftbar verriegelt (Blattfederverschluss)

Ventilated locked (laminated spring lock)

Einzelteile:
Components:

Für den nachträglichen Anbau eines Antriebes | for a later installation of the drive

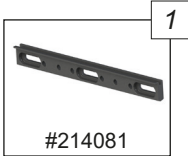

Einschiebling F100
Insert-sleeve F100

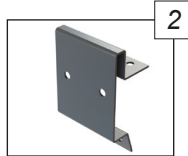

Beschlagsblech
blank
metal fitting blank

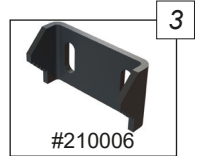

Verschlussstück
Blattfeder
closing part leaf
spring

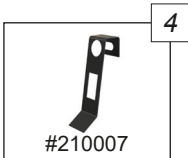

Blattfeder
laminated spring



Flügelbock
RAL 9016
wing bent RAL 9016

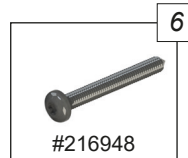

Linsenkopfschraube
AW25 5,5x45
raised-head screw
AW25 5,5x45

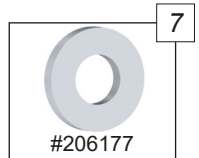

Unterlegscheibe
dick ø=6,4
washer thick ø=6,4

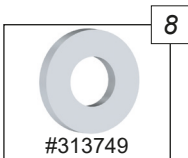

Sicherungsscheibe
ø=6,4
lock washer ø=6,4



Innensechskant-
schraube M6x12
socket screw M6x12

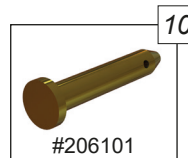

Aufnahmebolzen
locating bolt

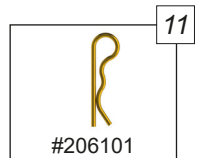

Sicherungssplint
lock splint

Montage:
Assembly:

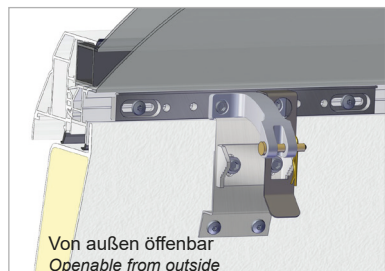
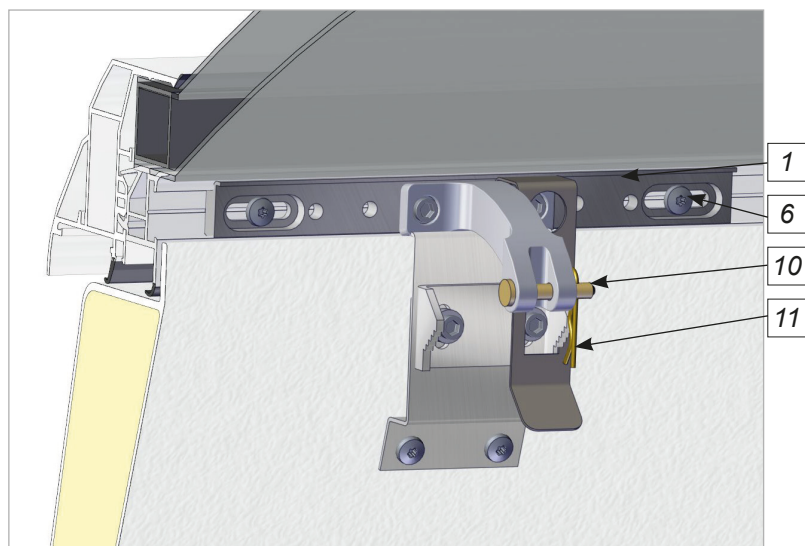
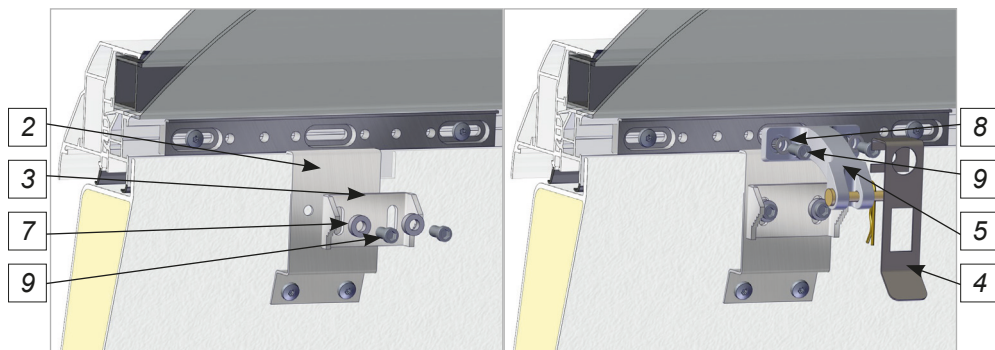

Wenn keine Öffnungsmöglichkeit von außen bestehen darf und kein Öffneraggregat eingebaut wird, Blattfeder nach links versetzen.

If a possibility to open from the outside is not allowed and no opener unit is installed, the leaf spring must be moved to the left side.

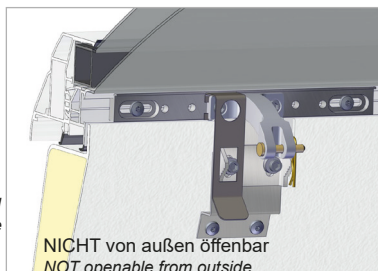

Starr verschraubt (Z-Blech ohne Antrieb)

Rigidly bolted (Z sheet without drive)

Einzelteile:
Components:

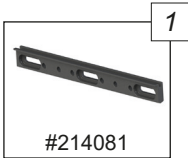

Einschiebling F100
Insert-sleeve F100

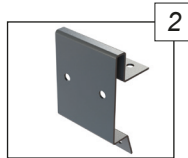

Beschlagsblech
blank
metal fitting blank

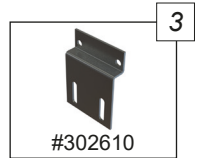

Verriegelungsblech
Z-Blech
Locking plate Z-sheet

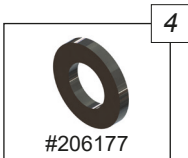

Unterlegscheibe
dick $\varnothing=6,4$
washer thick $\varnothing=6,4$



Innensechskant-
schraube M6x12
socket screw M6x12

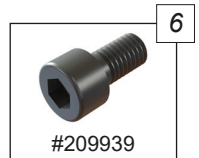

Innensechskant-
schraube M6x10
socket screw M6x10

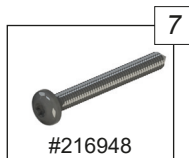

Linsenkopfschraube
AW25 5,5x45
raised-head screw
AW25 5,5x45

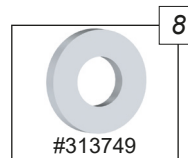

Sicherungscheibe
 $\varnothing=6,4$
lock washer $\varnothing=6,4$

Montage:
Assembly:

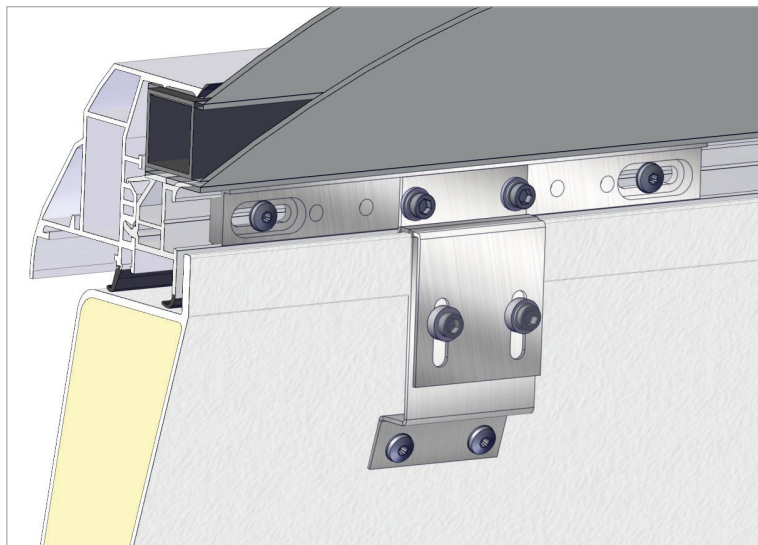
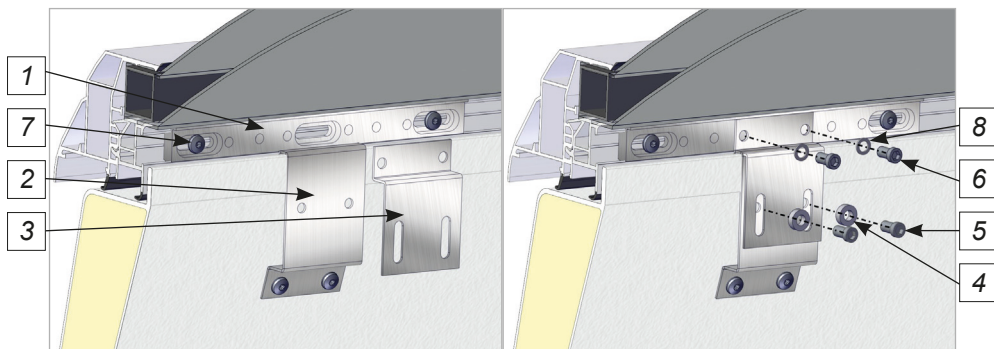

Zahnstangen-Antrieb Typ "ZA"

Rack and pinion drive type "ZA"

Einzelteile:
Components:

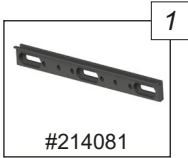

Einschiebling F100
insert-sleeve F100

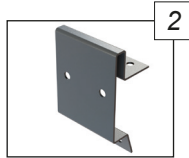

Beschlagsblech
blank
metal fitting blank

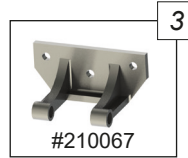

Winkelkonsole WK6
angle console WK6

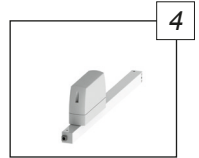

Elektromotor ZA
drive ZA

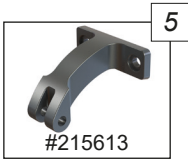

Flügelbock
RAL 9016
wing bent RAL 9016

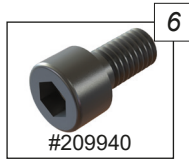

Innensechskant-
schraube M6x12
socket screw M6x12

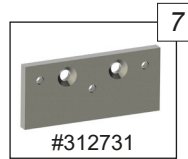

Adapterplatte WK6
adapter plate WK6

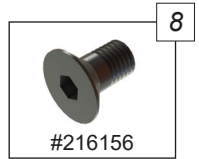

Senkkopfschraube
M6x10
countersunk M6x10

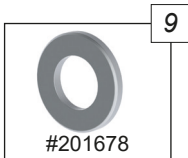

Scheibe DIN 125
6,4
washer DIN 125 6,4



Linsenkopf
AW25 5,5x45
raised-head screw
AW25 5,5x45

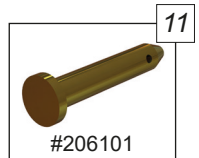

Aufnahmebolzen
locating bolt

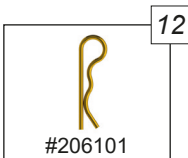

Sicherungssplint
lock splint



Gewindestift M8
threaded pin M8

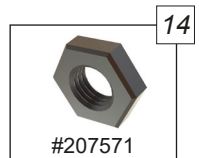

Sechskantmutter
M8
hexagonal nut M8

Montage:
Assembly:

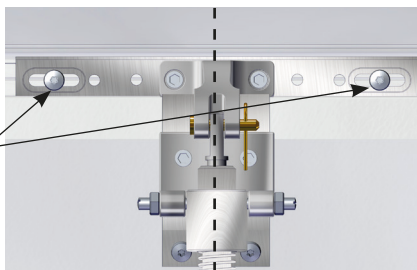

Flügelbock und Einschiebling
mittig zur Motoraugenschraube
ausrichten.
Pos.10 zum Ausrichten lösen.

*Align hinge bracket and connecting
sleeve centred to the eyebolt of the
drive.*

Remove position 10 for alignment.

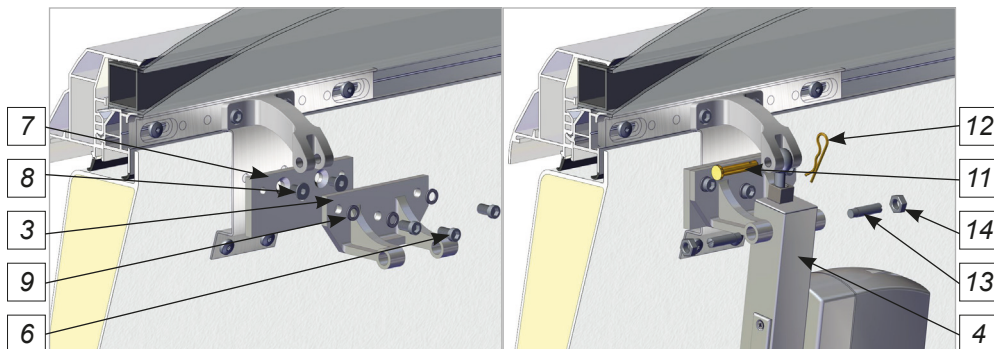

Der Öffnerantrieb soll noch leichtgängig in der Konsole schwenkbar sein.

The opener drive should be smoothly slewable in the bracket.

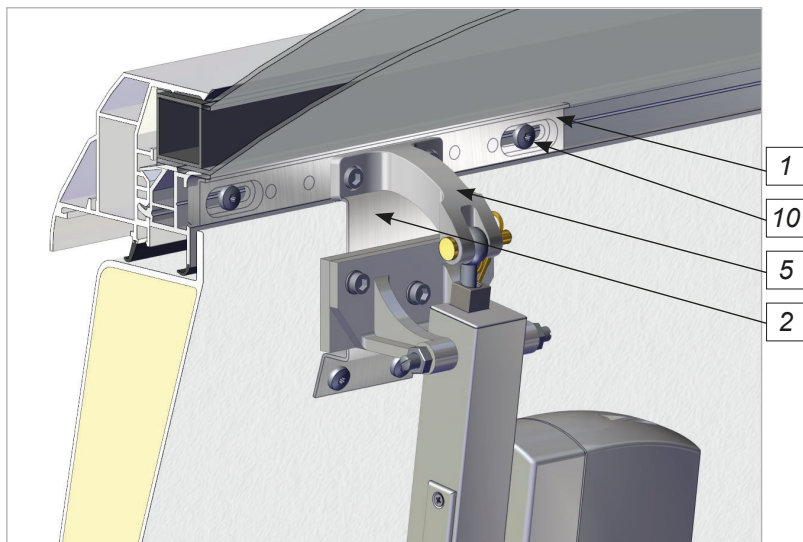

Teleskop-Spindeltrieb (Handspindel)

Telescope spindle drive (hand spindle)

Einzelteile:

Components:

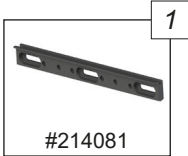

Einschiebling F100
Insert-sleeve F100

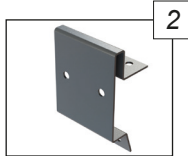

Beschlagsblech
blank
metal fitting blank

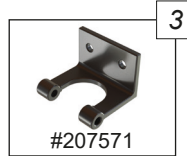

Spindelkonsole
spindle bracket

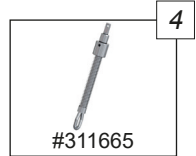

Teleskop-Spindel
telescope spindle

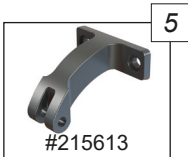

Flügelbock
RAL 9016
wing bent RAL 9016

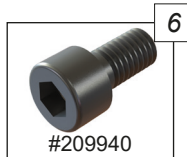

Innensechskant-
schraube M6x12
socket screw M6x12

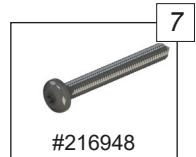

Linsenkopf
AW25 5,5x45
*raised-head screw
AW25 5,5x45*

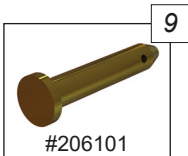

Aufnahmebolzen
locating bolt

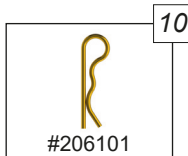

Sicherungssplint
lock splint

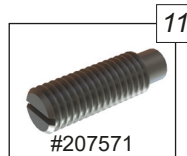

Gewindestift M8
threaded pin M8

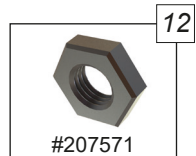

Sechskantmutter
M8
hexagonal nut M8

Montage:
Assembly:

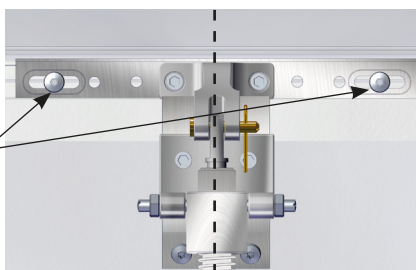

Flügelbock und Einschiebling
mittig zur Motoraugenschraube
ausrichten.
Pos.7 zum Ausrichten lösen.

*Align hinge bracket and connecting
sleeve centred to the eyebolt of the
drive.*

Remove position 7 for alignment.

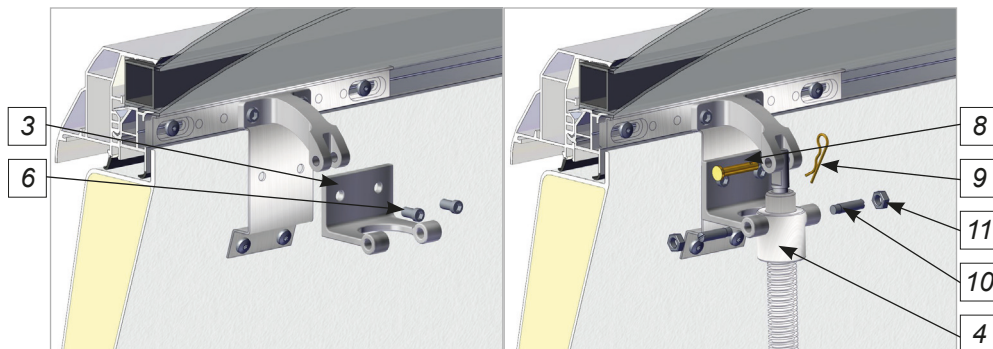

Der Öffnerantrieb soll noch leichtgängig in der Konsole schwenkbar sein.

The opener drive should be smoothly slewable in the bracket.

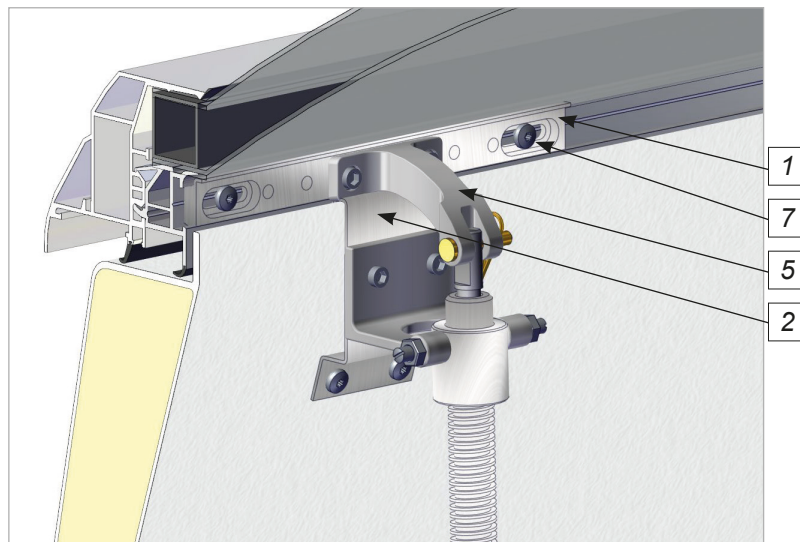

Pneumatikzylinder

Pneumatic cylinder

Einzelteile:
Components:

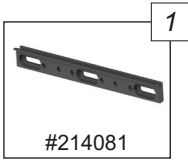

Einschiebling F100
Insert-sleeve F100

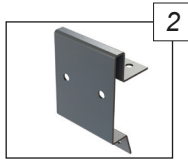

Beschlagsblech
blank
metal fitting blank

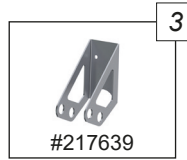

Motorkonsole
motor console

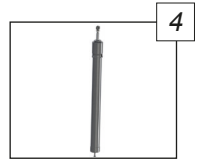

Pneumatikzylinder
pneumatic cylinder

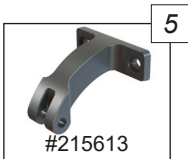

Flügelbock
RAL 9016
wing bent RAL 9016

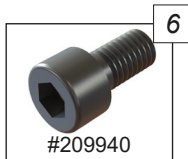

Innensechskant-
schraube M6x12
socket screw M6x12

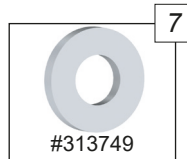

Sicherungsscheibe
ø=6,4
lock washer ø=6,4

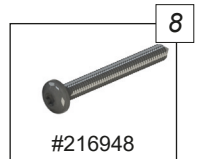

Linsenkopf
AW25 5,5x45
raised-head screw
AW25 5,5x45

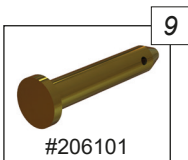

Aufnahmebolzen
locating bolt

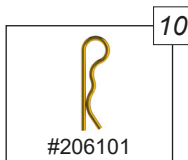

Sicherungssplint
lock splint

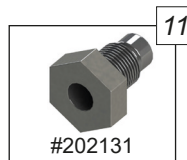

Entlüftungsver-
schraubung
ventilation screw
connection

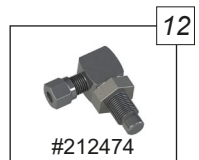

Winkel-Drehver-
schraubung
swivel elbow screw
connection

Montage:
Assembly:

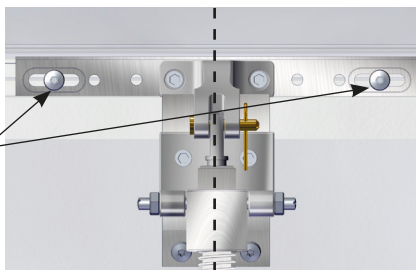

Flügelbock und Einschiebling
mittig zur Motoraugenschraube
ausrichten.
Pos.8 zum Ausrichten lösen.

*Align hinge bracket and connecting
sleeve centred to the eyebolt of the
drive.*

Remove position 8 for alignment.

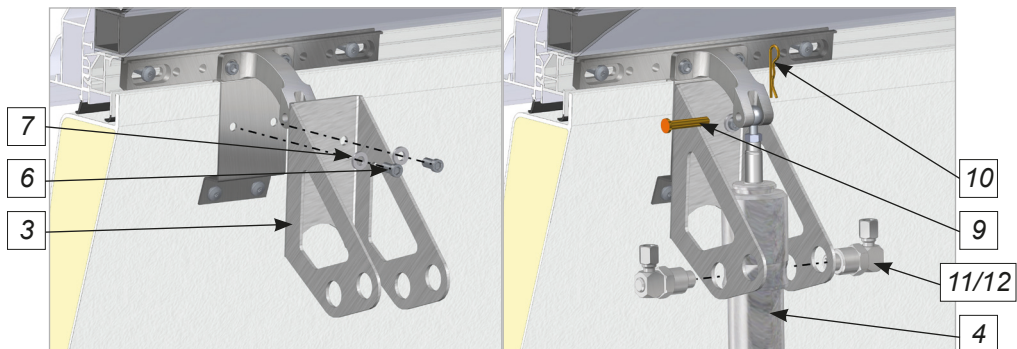

Der Öffnerantrieb soll noch leichtgängig in der Konsole schwenkbar sein.

The opener drive should be smoothly slewable in the bracket.

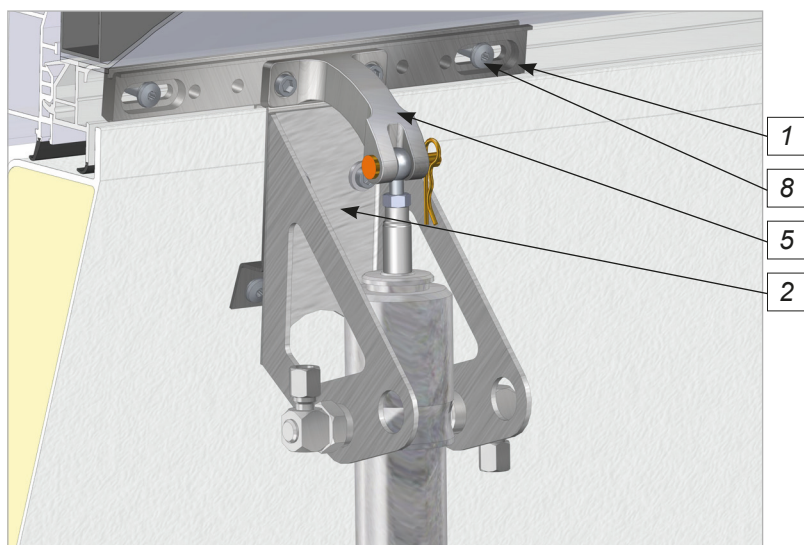

Pneumatikzylinder mit Rohrklammanschluss

Pneumatic cylinder with pipe clamp connection

Einzelteile:

Components:

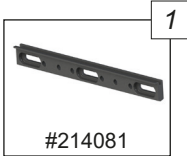

Einschiebling F100
Insert-sleeve F100

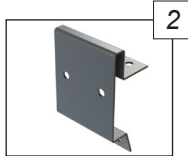

Beschlagsblech
blank
metal fitting blank

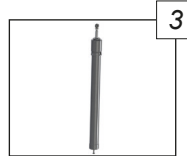

Pneumatikzylinder
pneumatic cylinder

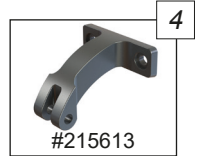

Flügelbock
RAL 9016
wing bent RAL 9016

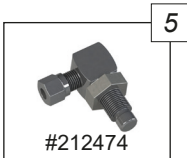

Winkel-Drehver-
schraubung
*swivel elbow screw
connection*

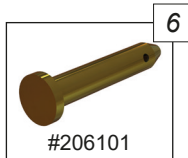

Aufnahmebolzen
locating bolt

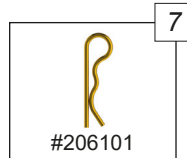

Sicherungssplint
lock splint

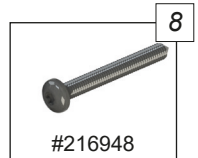

Linienkopf
AW25 5,5x45
*raised-head screw
AW25 5,5x45*

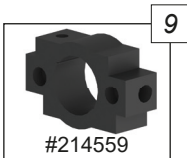

Rohrklammanschluss
pipe clamp connection

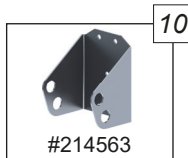

Konsole für
Rohrklammanschluss
*console for pipe clamp
connection*

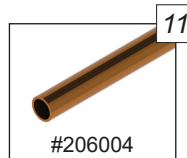

CU-Rohr 6x1mm
CU-pipe 6x1mm

Montage:
Assembly:

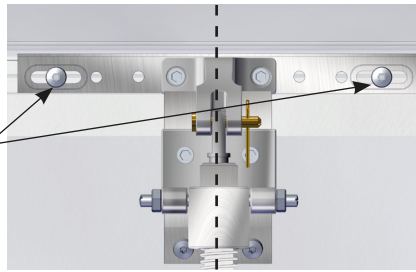

Flügelbock und Einschiebling
mittig zur Motorauschiebling
ausrichten.
Pos.8 zum Ausrichten lösen.

*Align hinge bracket and connecting
sleeve centred to the eyebolt of the
drive.*

Remove position 8 for alignment.

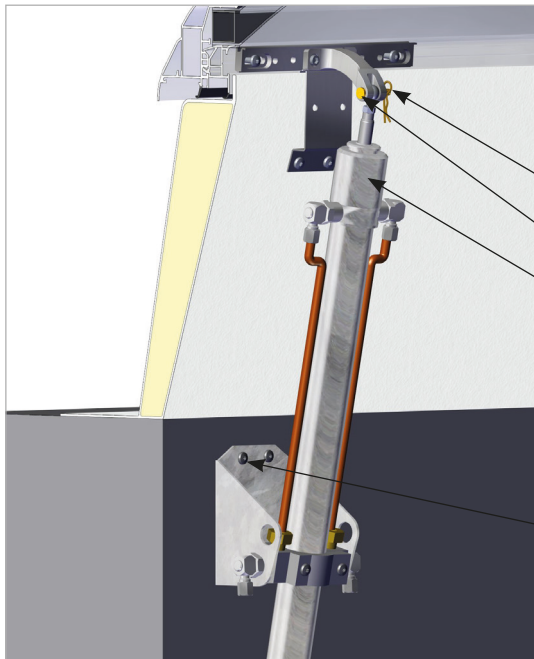
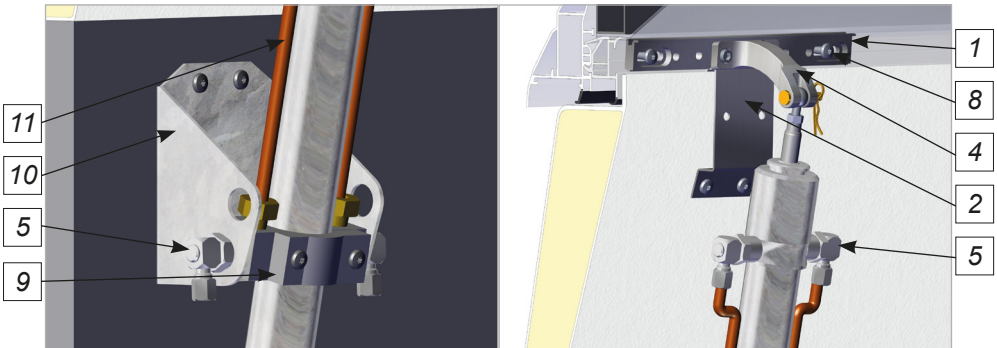

Der Öffnerantrieb soll noch leichtgängig in der
Konsole schwenkbar sein.

*The opener drive should be smoothly slewable in the
bracket.*



Befestigungsmittel an der Unterkonstruktion gehö-
ren nicht zum Lieferumfang.
Befestigungsmittel mit bauaufsichtlicher Zulassung
sind verwendbar.

*Fastening material at the substructure is not included in
scope of delivery.
Fastening material with technical approval could also be
used.*

230V Motor tandem Typ "JMBB"

230V drive tandem type "JMBB"

Einzelteile:
Components:

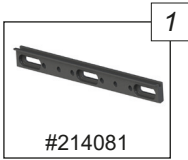

Einschiebling F100
Insert-sleeve F100

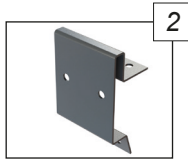

Beschlagsblech
blank
metal fitting blank



Motorconsole
motor console

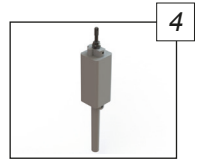

Elektromotor 230V
driver 230V

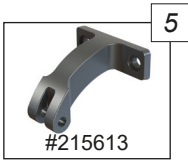

Flügelbock
RAL 9016
wing bent RAL 9016

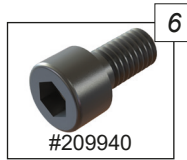

Innensechskant-
schraube M6x12
socket screw M6x12

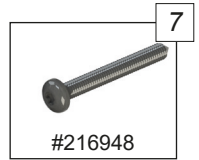

Linsenkopf
AW25 5,5x45
*raised-head screw
AW25 5,5x45*

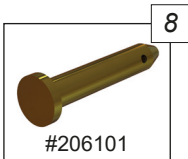

Aufnahmebolzen
locating bolt

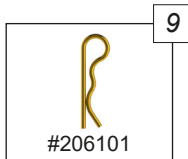

Sicherungssplint
lock splint

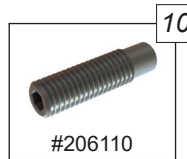

Gewindestift
M10x25
threaded pin M10x25

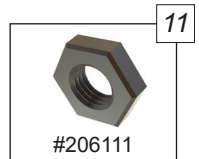

Sechskantmutter
M10
hexagonal nut M10

Montage:
Assembly:

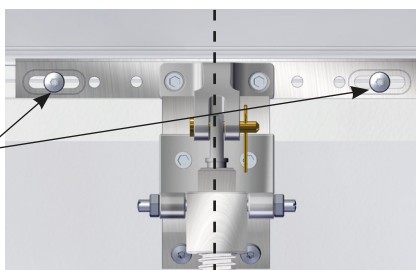

Flügelbock und Einschiebling
mittig zur Motoraugenschraube
ausrichten.
Pos.7 zum Ausrichten lösen.

*Align hinge bracket and connecting
sleeve centred to the eyebolt of the
drive.*

Remove position 7 for alignment.

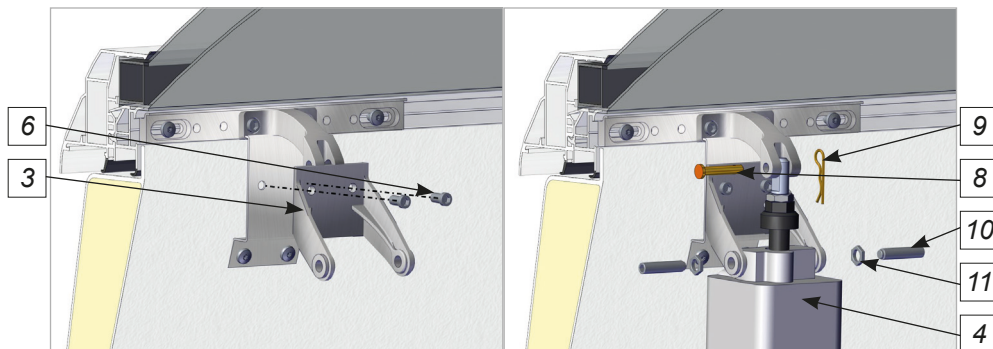

Der Öffnerantrieb soll noch leichtgängig in der Konsole schwenkbar sein.

The opener drive should be smoothly slewable in the bracket.

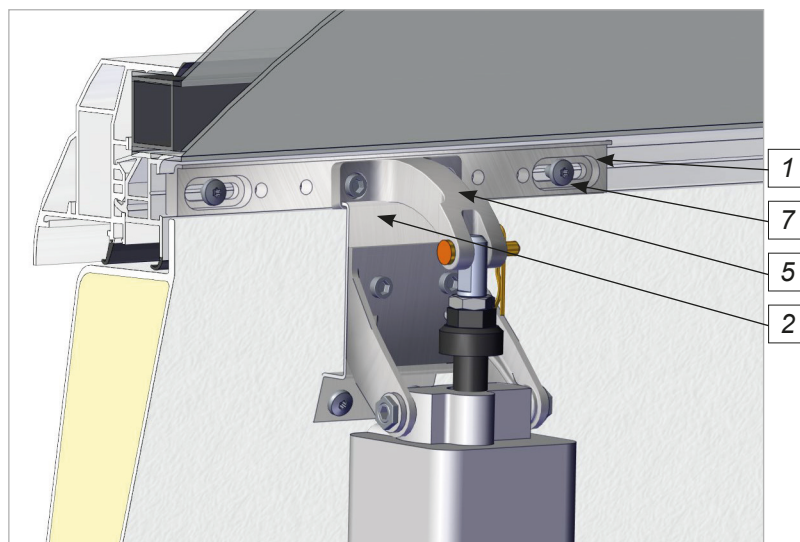

24V Motor tandem Typ "JM-DC"

24V drive tandem type "JM-DC"

Einzelteile:
Components:

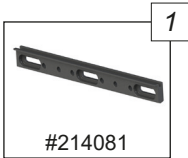

Einschiebling F100
Insert-sleeve F100

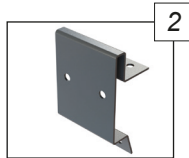

Beschlagsblech
blank
metal fitting blank

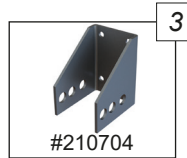

Motorconsole
motor console

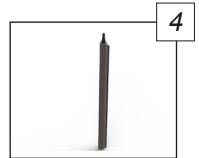

Elektromotor 24V
driver 24V

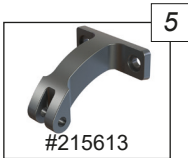

Flügelbock
RAL 9016
wing bent RAL 9016

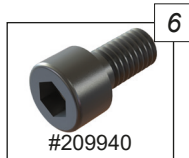

Innensechskant-
schraube M6x12
socket screw M6x12

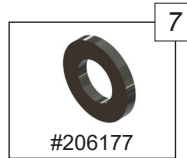

Unterlegscheibe
dick, Ø=6,4
flat washer thick,
Ø=6,4

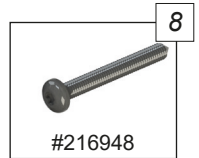

Linsenkopf
AW25 5,5x45
raised-head screw
AW25 5,5x45

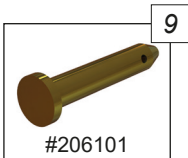

Aufnahmebolzen
locating bolt

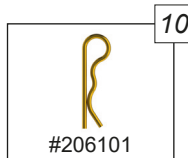

Sicherungssplint
lock splint

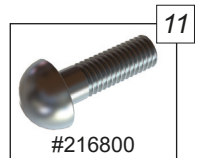

Stiftschraube M5
stud screw M5

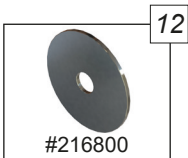

Unterlegscheibe
Ø=5,2
flat washer Ø=5,2

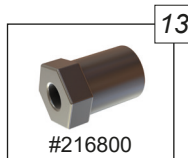

Schraubhülse M5
threaded bush M5



Lastabschaltung
load breaking

Montage:
Assembly:

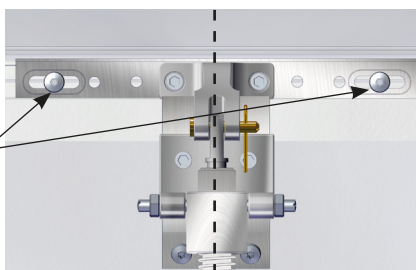

Flügelbock und Einschiebling
mittig zur Motoraugenschraube
ausrichten.
Pos.8 zum Ausrichten lösen.

*Align hinge bracket and connecting
sleeve centred to the eyebolt of the
drive.*

Remove position 8 for alignment.

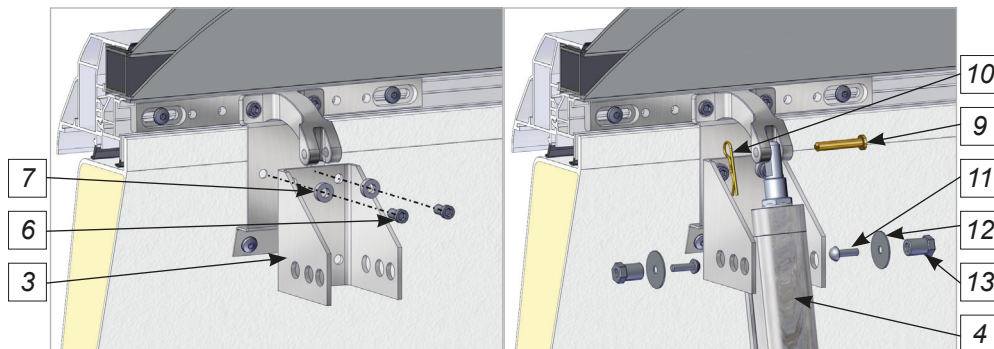

Der Öffnerantrieb soll noch leichtgängig in der Konsole schwenkbar sein.

The opener drive should be smoothly slewable in the bracket.

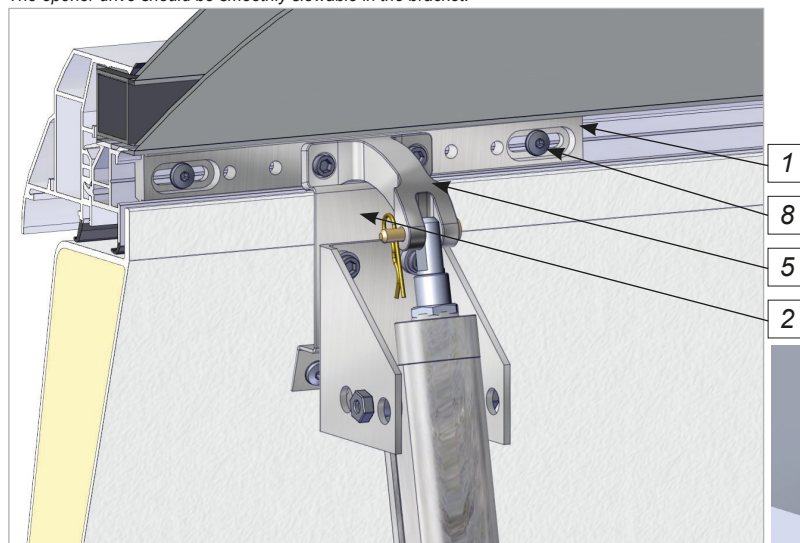

- 1
- 8
- 5
- 2
- 1



ODER
Montage Motorkonsole an Unterkonstruktion
OR
Installation of the motor bracket on the substructure

Kettenschubmotor Typ "KSA"

Chain drive type "KSA"

Einzelteile:
Components:

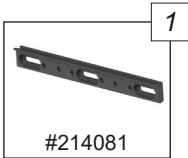

Einschiebling F100
Insert-sleeve F100

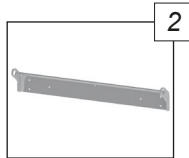

Konsole KSA Motor
console KSA driver

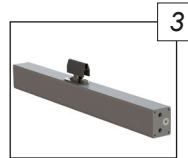

Elektromotor KSA
driver KSA

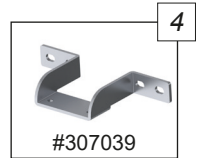

Flügelbockkonsole
wing bracket



Linsenkopf
AW25 5,5x45
raised-head screw
AW25 5,5x45

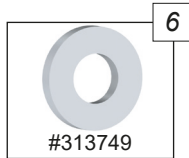

Sicherungsscheibe
ø=6,4
lock washer ø=6,4

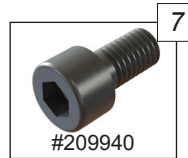

Innensechskant-
schraube M6x12
socket screw M6x12

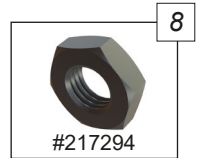

Mutter M5
nut M5

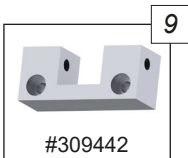

Flügelbock F16
wing bent F16

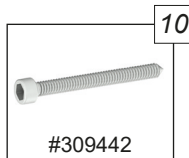

Zylinderschraube
M6x50
cylinder head screw
M6x50

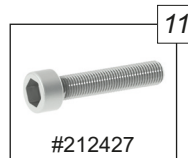

Zylinderschraube
M5x25
cylinder head screw
M5x25

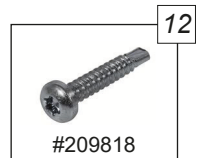

Bohrschraube
4,8x25 AW20
drilling screw
4,8x25 AW20

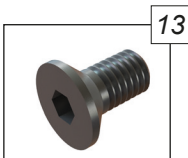

Senkkopfschraube
countersunk screw

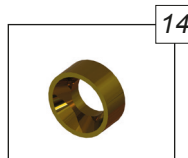

Distanzhülse
distance bush

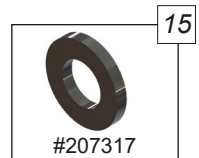

Unterlegscheibe
dünn, Ø=5,3
flat washer
thin Ø=5,3

Montage:
Assembly:

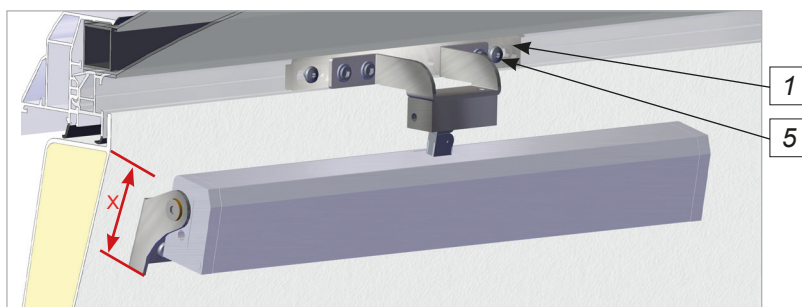
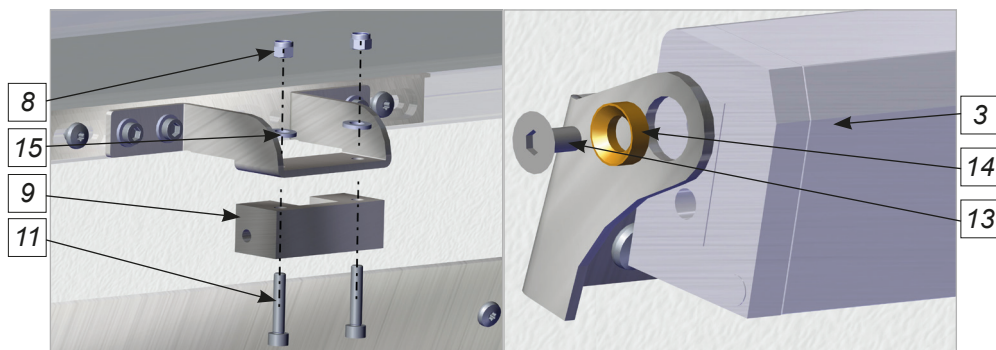
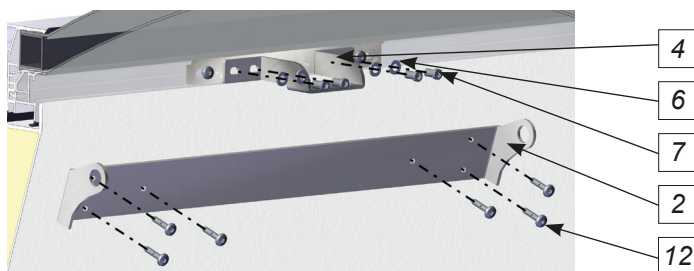

| Aufsatzkranz upstand | Maß X (mm) dimension X |
|--------------------------|---------------------------|
| K15 | 72 |
| K30 | 80 |
| K40 | 82 |
| K40-5° | 84 |
| K50 | 84 |
| GFK Aufstock- element | 89 |
| Senkrecht Vertical | 89 |

Hinweis:
Das Maß gilt ab Auflagefläche der Dichtung.

Attention:
The measure applies from the contact surface of the seal.

Der Öffnerantrieb soll noch leichtgängig in der Konsole schwenkbar sein.

The opener drive should be smoothly slewable in the bracket.

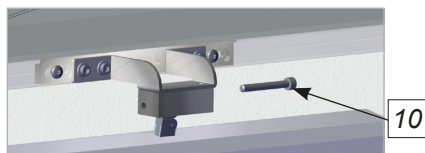

Kettenschubmotor Typ "Ne-Ka"

Chain drive type "Ne-Ka"

Einzelteile:
Components:

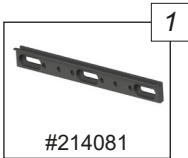

Einschiebling F100
Insert-sleeve F100

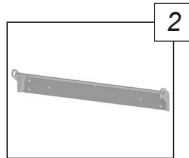

Konsole KSA Motor
console KSA driver

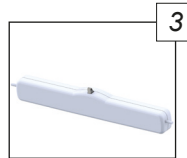

Elektromotor
Neka
driver Neka

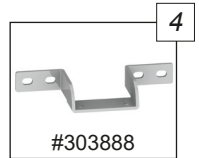

Flügelbockkonsole
wing bracket



Linienkopf
AW25 5,5x45
raised-head screw
AW25 5,5x45

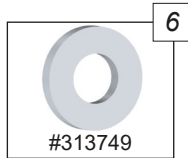

Sicherungsscheibe
ø=6,4
lock washer ø=6,4

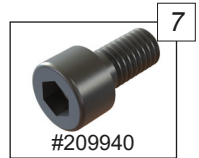

Innensechskant-
schraube M6x12
socket screw M6x12

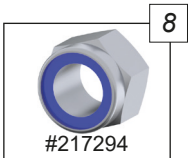

selbstsichernde
Mutter M5
self-locking nut M5

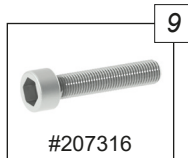

Zylinderschraube
M5x16
cylinder head screw
M5x16

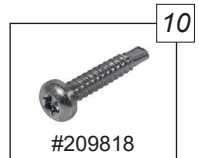

Bohrschraube
4,8x25 AW20
drilling screw
4,8x25 AW20

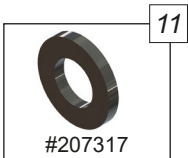

Unterlegscheibe
dünn, Ø=5,3
flat washer
thin Ø=5,3

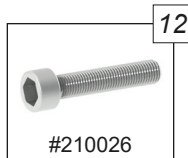

Zylinderschraube
M6x20
cykubder head screw
M6x20

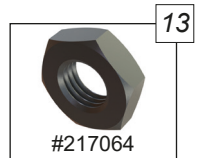

Sechskantmutter
M5
hexagon nut M5

Montage:
Assembly:

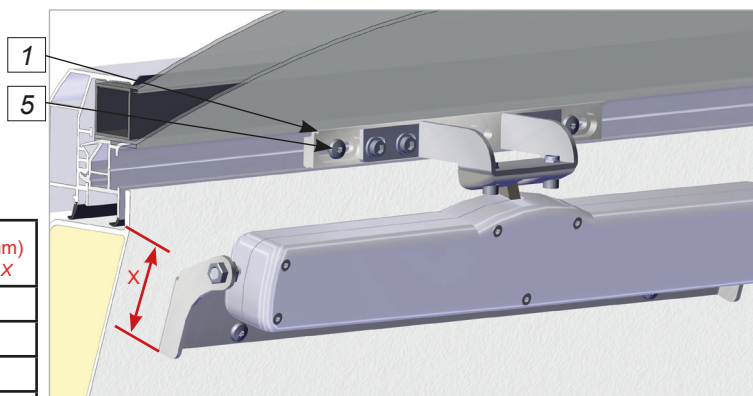
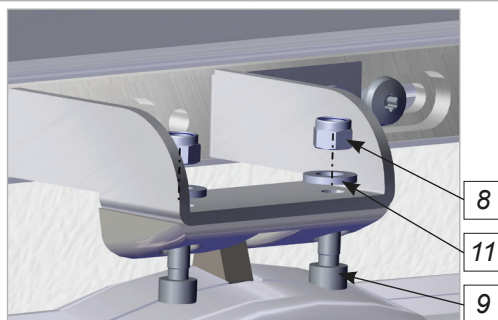
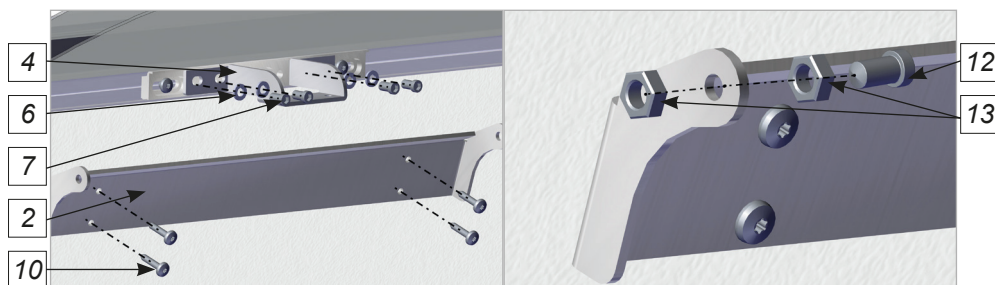

| Aufsatzkranz upstand | Maß X (mm) dimension X |
|--------------------------|---------------------------|
| K15 | 68 |
| K30 | 80 |
| K40 | 85 |
| K40-5° | 84 |
| K50 | 86 |
| GFK Aufstock- element | 91 |
| PVC Aufstock- element | 94 |
| Senkrecht Vertical | 95 |

Hinweis:
Das Maß gilt ab Auflagefläche der Dichtung.

Attention:
The measure applies from the contact surface of the seal.

Der Öffnerantrieb soll noch leichtgängig in der Konsole schwenkbar sein.

The opener drive should be smoothly slewable in the bracket.

Kettenschubmotor Typ "Windowmaster"

Chain drive type "Windowmaster"

Einzelteile:
Components:

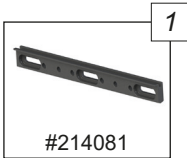

Einschleibling F100
insert-sleeve F100

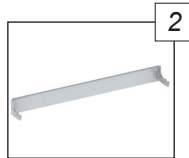

WMU-Konsole
WMU bracket

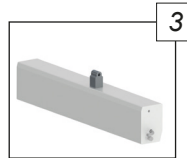

Kettenschubmotor
WMU
chain drive WMU

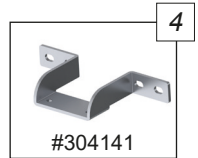

Flügelbockkonsole
für WMU 8xx
wing bracket for WMU
8xx



Linsenkopf
AW25 5,5x45
raised-head screw
AW25 5,5x45

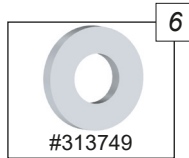

Sicherungsscheibe
ø=6,4
lock washer ø=6,4

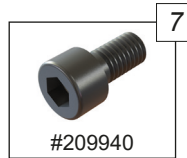

Innensechskant-
schraube M6x12
socket screw M6x12

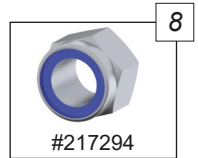

Selbstsichernde
Mutter M5
self-locking nut M5

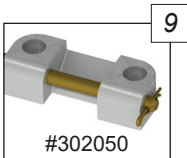

Flügelbock
wing trestle

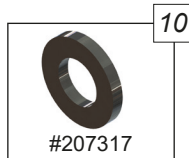

Unterlegscheibe
dünn, Ø=5,3
flat washer
thin Ø=5,3

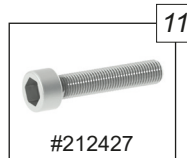

Zylinderschraube
M5x25
cylinder head screw
M5x25



Bohrschraube
4,8x25 AW20
drilling screw
4,8x25 AW20

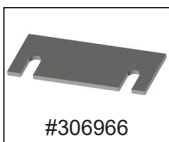

Distanzblech zwischen Flügelbockkonsole
und Flügelbock
- bei Bedarf
distance plate between wing bracket and wing
trestle
- if required

Montage:
Assembly:

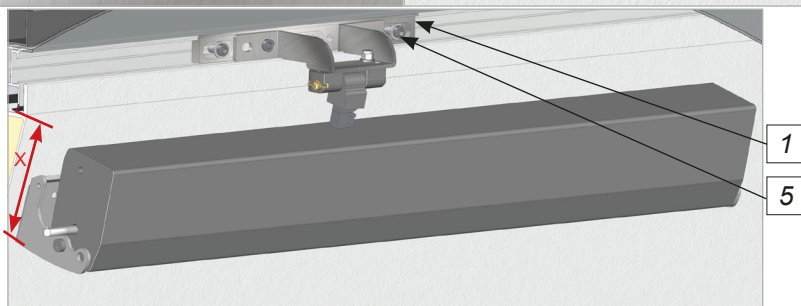
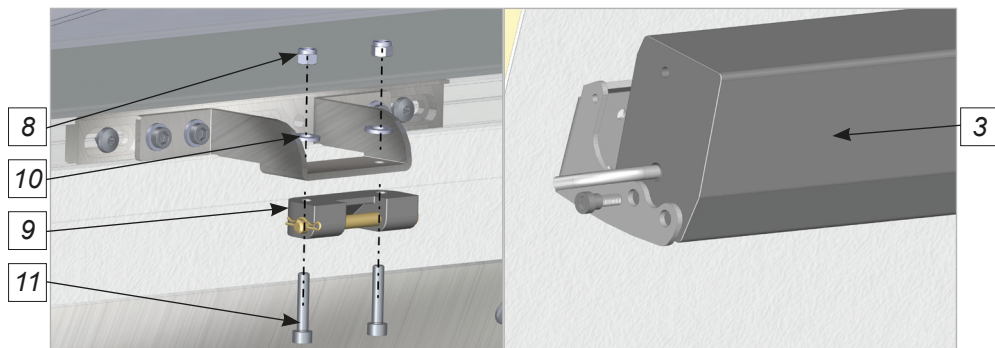
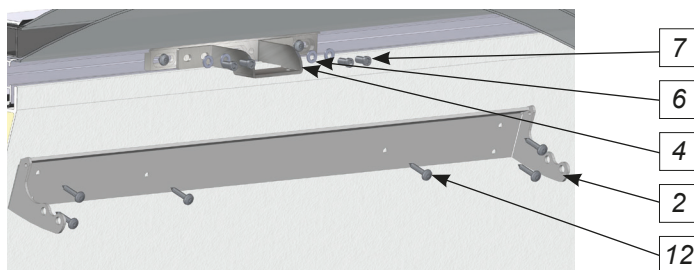

| Aufsatzkranz upstand | Maß X (mm) dimension X |
|--------------------------|---------------------------|
| K15 | 55 |
| K30 | 81 |
| K40 | 84 |
| K50 | 86 |
| GFK-Aufstock- element | 94 |
| PVC-Aufstock- element | 97 |
| Senkrecht Vertical | 96 |

Hinweis:
Das Maß gilt ab Auflagefläche der Dichtung.

Attention:
The measure applies from the contact surface of the seal.

Der Öffnerantrieb soll noch leichtgängig in der Konsole schwenkbar sein.

The opener drive should be smoothly slewable in the bracket.

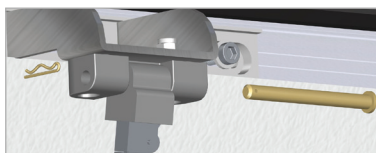

Anschlusspläne Elektromotoren

Wiring diagrams of electric drives

Zahnstangenantrieb Typ "ZA"
rack and pinion drive type "ZA"

| | | |
|---|---|--------------|
| Technische Daten <i>technical details</i> | 230V | 24V |
| Antriebstyp <i>driving force</i> | Zahnstangenantrieb <i>rack and pinion drive</i> | |
| Versorgung <i>maintenance</i> | 230V AC, 50Hz | 24V DC |
| Bemessungsstrom <i>rated current</i> | 27W / 30VA | 1A |
| Nennkraft <i>nominal force</i> | 1000N | 800N |
| Laufzeit <i>run-time</i> | ca. 10s/100mm | ca. 10s/71mm |
| Gehäuse <i>case</i> | Aluminium/Kunststoff <i>aluminium/plastic</i> | |
| Schutzart <i>safety class</i> | IP65 | |
| Kabellänge <i>cable length</i> | 2,5m | |

Solo/Tandem 230V

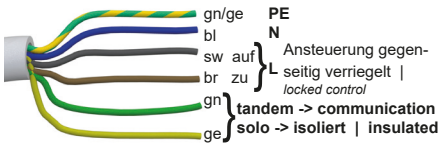

Solo/Tandem 24V

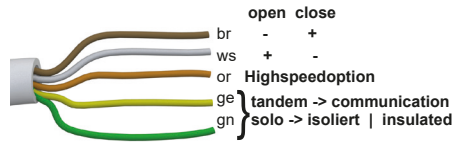

Achtung bei Tandemschaltung:

Zur Synchronisation müssen die "Kommunikationsadern" der Motoren miteinander verbunden werden.

Attention with tandem circuit:

To synchronise, the communication wires of the drives need to be connected with each other.

230V Motor Typ "JMBB"
230V driver type "JMBB"

| | |
|---|--|
| Technische Daten <i>technical details</i> | |
| Antriebstyp <i>driving force</i> | Spindelhubantrieb <i>spindle drive</i> |
| Versorgung <i>maintenance</i> | 230V AC, 50Hz |
| Bemessungsstrom <i>rated current</i> | 0,6A / 140W |
| Nennkraft <i>nominal force</i> | 550N |
| Laufzeit <i>run-time</i> | ca. 10s/100mm |
| Gehäuse <i>case</i> | Kunststoffgehäuse <i>plastic case</i> |
| Schutzart <i>safety class</i> | IP54 |
| Lastabschaltung <i>load breaking</i> | integriert <i>integrated</i> |
| Kabellänge <i>cable length</i> | 1,4m |

Solo/Tandem 230V

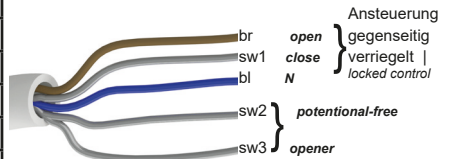

24V Motor Typ "JM-DC" 24V driver type "JM-DC"

| | | |
|---|--|---------------|
| Technische Daten <i>technical details</i> | Jo65 | Jo100 |
| Antriebstyp <i>driving force</i> | Spindelhubantrieb <i>spindle drive</i> | |
| Versorgung <i>maintenance</i> | 24V DC, +4/-2V | |
| Bemessungsstrom <i>rated current</i> | 0,8A / 19,2W | |
| Nennkraft <i>nominal force</i> | 650N | 1000N |
| Laufzeit <i>run-time</i> | ca. 375mm/min | ca. 200mm/min |
| Gehäuse <i>case</i> | Aluminium <i>aluminium</i> | |
| Schutzart <i>safety class</i> | IP65 | |
| Lastabschaltung <i>load breaking</i> | integriert <i>integrated</i> | |
| Kabellänge <i>cable length</i> | 1,7m - 2,4m | |

Solo/Tandem 24V

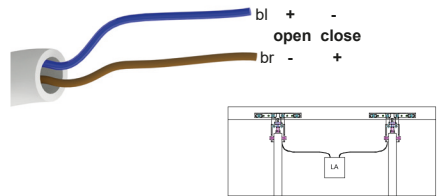

Um einen störungsfreien Betrieb zu gewährleisten müssen die Antriebe über eine externe Gleichaufregung synchronisiert werden!

To ensure a smooth operation, the drives need to be synchronised via an external synchronisation control!

Kettenschubmotor Typ "KSA" chain drive type "KSA"

| | | |
|---|---|----------------|
| Technische Daten <i>technical details</i> | 230V | 24V |
| Antriebstyp <i>driving force</i> | Kettenschubantrieb <i>chain drive</i> | |
| Versorgung <i>maintenance</i> | 230V AC, 50Hz | 24V DC, +4/-2V |
| Bemessungsstrom <i>rated current</i> | 0,2A | 1,2A |
| Abmessungen <i>dimension</i> | B 40mm x H 56mm | |
| Nennkraft <i>nominal force</i> | 600N | |
| Laufzeit <i>run-time</i> | ca. 8mm/s | ca. 12mm/s |
| Gehäuse <i>case</i> | Aluminium <i>aluminium</i> | |
| Schutzart <i>safety class</i> | IP32 | |
| Lastabschaltung <i>load breaking</i> | integriert <i>integrated</i> | |
| Kabellänge <i>cable length</i> | 5m | |

Solo/Tandem 230V

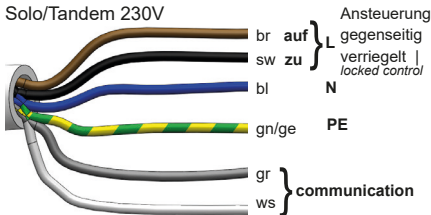

Solo/Tandem 24V

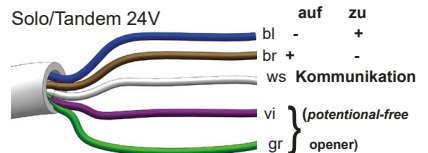

Achtung bei Tandemschaltung:

Zur Synchronisation müssen die "Kommunikationsadern" der Motoren miteinander verbunden werden.

Attention with tandem circuit:

To synchronise, the communication wires of the drives need to be connected with each other.

Kettenschubmotor Typ "Ne-Ka"
chain drive type "Ne-Ka"

| | | |
|--|--|--------------|
| Technische Daten <i>technical details</i> | 230V | 24V |
| Antriebstyp <i>driving force</i> | Kettenschubantrieb <i>chain drive</i> | |
| Versorgung <i>maintenance</i> | 230V | 24V |
| Stromverbrauch <i>current drain</i> | 0,115A | 0,88A |
| Abmessungen <i>dimension</i> | L ca. 386,5mm <i>L approx. 386,5mm</i> | |
| max. Schub-/Zugkraft <i>maximum thrust/ tractive force</i> | 250N | |
| Laufzeit <i>run-time</i> | ca. 12,5mm/s | ca. 12,5mm/s |
| Gehäuse <i>case</i> | Aluminium <i>aluminium</i> | |
| Schutzart <i>safety class</i> | IP30 | |
| Lastabschaltung <i>load breaking</i> | integriert <i>integrated</i> | |
| Kabellänge <i>cable length</i> | 2m | |

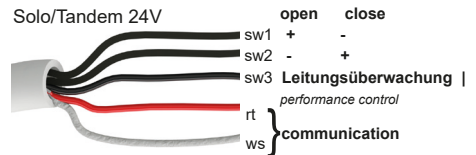
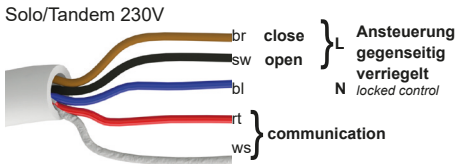

Achtung bei Tandemschaltung:

Zur Synchronisation müssen die "Kommunikationsadern" der Motoren miteinander verbunden werden.

Attention with tandem circuit:

To synchronise, the communication wires of the drives need to be connected with each other.

Kettenschubmotor Typ "Windowmaster"
chain drive type "Windowmaster"

| | |
|---|---|
| Technische Daten <i>technical details</i> | |
| Antriebstyp <i>driving force</i> | Kettenschubantrieb <i>chain drive</i> |
| Versorgung <i>maintenance</i> | 24V DC |
| Stromverbrauch <i>current drain</i> | 1 - 5A |
| Nennkraft <i>nominal force</i> | 600N oder 1000N <i>600N or 1000N</i> |
| Laufzeit <i>run-time</i> | je nach Antrieb <i>depending on the drive</i> |
| Gehäuse <i>case</i> | Aluminium <i>aluminium</i> |
| Schutzart <i>safety class</i> | IP54 |
| Lastabschaltung <i>load breaking</i> | integriert <i>integrated</i> |
| Kabellänge <i>cable length</i> | 5m |

Solo/Tandem 24V

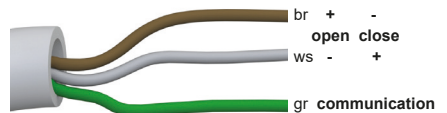

Achtung bei Tandemschaltung:

Zur Synchronisation müssen die "Kommunikationsadern" der Motoren miteinander verbunden werden.

Attention with tandem circuit:

To synchronise, the communication wires of the drives need to be connected with each other.

Kontakte

Contacts

Abteilung Lichtkuppel | Flachdach Fenster
Department Rooflight | Glass Skylight



Heiko Sachs
Telefon | *Phone*: +49 9283 595-1677
E-Mail: Heiko.Sachs@lamilux.de



Ingo Michel
Telefon | *Phone*: +49 9283 595-222
E-Mail: Ingo.Michel@lamilux.de

Abteilung Steuerungstechnik | Gebäudesteuerung
Department Control Technology | Building Automation



Fabian Sachs
Telefon | *Phone*: +49 9283 595-1648
E-Mail: Fabian.Sachs@lamilux.de



Alexander Wojewutko
Telefon | *Phone*: +49 9283 595-228
E-Mail: Alexander.Wojewutko@lamilux.de



Hier scannen und mehr zu
LAMILUX Tageslichtsystemen erfahren!



LICHTKUPPEL F100



FLACHDACH FENSTER F100



FLACHDACH FENSTER FE



GLASARCHITEKTUR



SANIERUNG



MIROTEC STAHLKONSTRUKTIONEN



LICHTBAND B



LICHTBAND S



LICHTBAND W|R



RAUCH- UND
WÄRMEABZUGSANLAGEN



GEBÄUDESTEUERUNGEN



RODA LICHT-
UND LÜFTTECHNIK

Die in diesem Prospekt aufgeführten technischen Daten entsprechen dem aktuellen Stand bei Drucklegung und können sich ändern. Unsere technischen Angaben beziehen sich auf Berechnungen, Lieferantangaben oder wurden im Rahmen einer Prüfung von einem unabhängigen Prüfinstitut nach den jeweils gültigen Normen ermittelt. Die Berechnung der Wärmedurchgangskoeffizienten für unsere Kunststoffverglasungen erfolgte nach der „Methode der finiten Elemente“ mit Referenzwerten nach DIN EN 673 für Isoliergläser. Dabei wurde – der Praxis und den spezifischen Kunststoff-Merkmalen Rechnung tragend – die Temperaturdifferenz 15 K zwischen den Materialaußenflächen definiert. Die Funktionswerte beziehen sich nur auf Prüfstücke in den für die Prüfung vorgesehenen Abmessungen. Eine weitergehende Garantie für technische Werte wird nicht übernommen. Dies gilt insbesondere für veränderte Einbausituationen oder wenn Nachmessungen am Bau erfolgen.



LAMILUX Heinrich Strunz GmbH

Zehstraße 2 · Postfach 1540 · 95111 Rehau · Tel.: +49 (0) 92 83 / 5 95-0 · Fax +49 (0) 92 83 / 5 95-29 0

E-Mail: information@lamilux.de · www.lamilux.de

