



LAMILUX GLASS ARCHITECTURE
LIVING WITH LIGHT

LIVING WITH LIGHT – CONTEMPORARY AND ENERGY-EFFICIENT

"Let us create buildings that turn the outdoors into the indoors: comfortably bright, with a pleasant climate, energy-efficient, and visually appealing. Glass is the best material for this. This is why we have spent decades developing optimum and customised solutions for glass roofs of all building types. Let the following pages speak for themselves as they show you how we involve the maximum degree of daylight in your building project using state-of-the-art glass architecture."

Michael Wagner Head of Sales Skylights

The LAMILUX CI Philosophy

Customer value is the reason we exist – and the focus of our activities. This requires harmony, identity and a balance between customer value and company strategy.

The principles that guide our company's actions and customer relations are set out in LAMILUX's company philosophy:

Customized Intelligence – serving customers is our first priority:

This requires outstanding performance and leadership in all areas relevant to customers, particularly in the role of:

- A leader in quality – optimum benefit for customers
- A leader in innovation – at the cutting edge of technology
- A leader in service – fast, uncomplicated, reliable and friendly
- A leader in expertise – optimum sales and technical advisory services
- A leader in solving problems – customised, made-to-order solutions



Content

LAMILUX Glass Roof PR60

Product description

Page 6

Glass Roof PR60 Passivhaus

Page 8

Renovation

Page 10

Steel Constructions with MIROTEC

Page 14

References

Page 16

Ventilation Flap PR60

Page 20

Smoke Lift Glass Roof PR60

Page 22

Control Technology

Page 24

Solutions for optimum structural attachment

Page 26

Accessories

Page 28

Modular Glass Skylight MS78

Page 30

Glass Skylight Fire Resistance

Page 36

LAMILUX

GLASS ROOF PR60

Design glass roofs that are tailored to the individuality of your building project: The LAMILUX Glass Roof PR60 is based on a highly flexible mullion-transom system and enables almost all conceivable shapes at angles between zero and 90 degrees: from saddleback and hipped roofs, pyramids and arched roofs to fully customised geometries.

The system has considerable dimensional stability, particularly at the supporting joints, thanks to the specially interlocking slide-in connectors. This facilitates complicated profile joints without any difficulty. In addition, the narrow face width of the profiles (60 millimetres) ensures a high level of daylight intake – hence the 60 in the name of our mullion-transom construction. The LAMILUX Glass Roof PR60 is available in many glazing types, such as heat insulation glass, sun protection and sound insulation glass as well as light-guiding and light-dispersing glazing types. The large number of optional shade systems ensure controlled daylight intake.



Cover strips with splash water duct
(available with optional cover profile)

High degree of driving rain tightness and airtightness thanks to
continuous EPDM outer seal

Thermally optimised insulation core

Double or triple glazing
available in many glazing types

Internal, multi-stage seal system
with secondary water drainage

High intake of daylight thanks to narrow support profiles



STABILITY AND ENERGY EFFICIENCY IN THE SPOTLIGHT

The LAMILUX Glass Roof PR60 is an all-round sophisticated system which stands for a high degree of safety on the roof in addition to architecturally appealing structures, a high intake of daylight and energy-efficient construction. The EPDM outer seal and the special arrangement of the frame profiles enables unobstructed drainage of rainwater before it can enter the construction. The seal system, which was specially developed for the inner sealing layer ensures efficient ventilation of the glazing rebate and controlled water and condensate drainage. If water does find its way into the construction, the secondary water drainage takes effect thanks to the jointless and overlapping seal system which ensures unobstructed drainage of the water without damaging the glazing rebate. This completely rules out milky panes.

In combination with the construction's own insulation core, the seal system provides optimum isothermal lines. As the entire construction is thermally separated, the glass roof becomes the active energy manager of the building: The heat stays outside in summer and inside in winter. The glass roof enables a high intake of daylight thanks to its narrow support profiles and large glass surfaces. In addition, the system's functions are reliable in the event of extreme weather events. This has been shown in tests for impermeability to driving rain, airtightness and resistance to wind load.



Overlapping transom seal

Cold-cured, permanently elastic connection to the rafter seal

Continuous, jointless rafter seal

With secondary drainage and glazing rebate ventilation



LAMILUX

GLASS ROOF PR60 PASSIVHAUS

The LAMILUX Glass Roof PR60 Passivhaus is the optimum, energy-efficient solution. The product variant has an optimised insulation core thereby making it thermally separated to an even better extent. This is combined with a special edge bond which, in turn, thermally enhances the glazing. As a result, our Glass Roof PR60 Passivhaus is the first sloped glazing in the world to have been certified for the highest Passivhaus efficiency class – “phA advanced component”.

In addition to the special heat insulation, the considerable airtightness is a further advantage of this variant. The sophisticated combination of highly efficient materials and innovative production technology make this glass roof unique. This can also be seen in the free shaping and freedom of design that are of course also fully present in the Passivhaus variant.

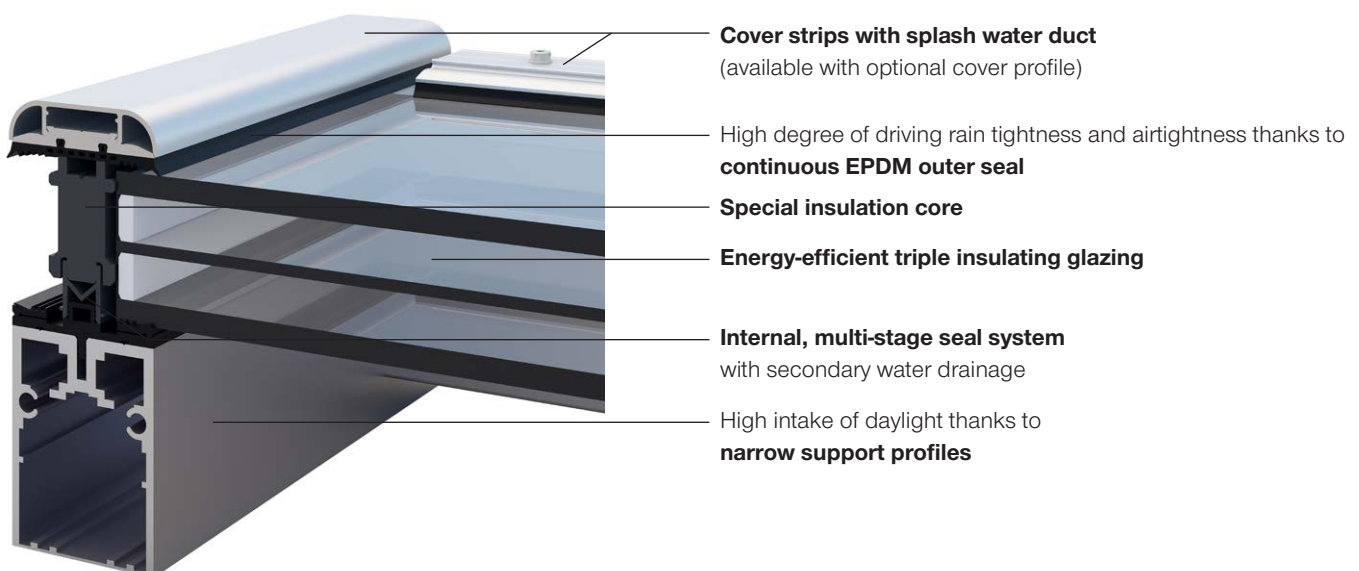



RENOVATION

This is what renovation of glass roof constructions with LAMILUX means for you: All processes run smoothly and primarily have a single focus: Comprehensive and optimum service for the customer – from planning to installation, all from a single source. To this end, we record all the requisite parameters involved in the renovation using a detailed checklist before putting the clearly regulated steps into practice by the given deadline.

We have been renovating skylights throughout Europe in this way for decades. You benefit from this experience, from our product diversity and our focus on customer-specific projects. Our goal is to develop and implement a technically impressive, innovative, sophisticated and, at the same time, cost-efficient solution for you.



Renovation example: University of Music and Performing Arts, Munich

Prior to the renovation

Heat energy was shown to escape from the old glass roof. The supporting structure had become unstable and the partly opaque glass panes were only letting a small amount of daylight into the building.

After the renovation

- Two hipped glass roofs with a surface inclination of 20° with dado wall panelling
- Coating of both constructions in customised RAL colours
- Option of daily aeration and ventilation with 24 LAMILUX ventilation flaps PR60
- Activation of the systems by means of 24 motor openers as flap drives for ventilation and SHEV function
- Installation of supply cable and flap control connection to the existing building control system





Michael Wohlfahrt, Technical Department Project Manager



Simone Ritter, Glass Construction Engineer

ANALYSIS

The details of the renovation process are recorded in an extensive checklist. Together with the customer, the functional and energetic requirements for the new systems are defined. Interfaces are clarified and a survey is conducted. For example:

- What is the condition of the material?
- Is the supporting structure still usable?
- Is it necessary to replace the entire old construction with a completely new one?

PRELIMINARY PLANNING

We draw on the following to develop a cost-efficient concept:

- Our wide range of products, particularly with regard to energy efficiency and the desired functions
- Customised, building-specific adaptation of skylights
- A transparent depiction of the costs in a detailed offer depicting the system
- A renovation solution according to your specifications and an appropriate cost-efficiency assessment

This is what you can expect from us:

- We will design and plan your daylight system in detail.
- We will create a binding approval drawing for you.
- You will receive proof of the energetic qualities of the skylights.
- We will assist you with any relevant questions you might have in the approval phase.



Uwe Voigtländer, Glass Construction Production Manager



Uwe Riedelbauch, Safety Technology Installation Supervisor

PRODUCTION

We give production processing top priority. This includes:

- Incoming goods inspection
- Creation of production schedules
- Production planning
- Sustainable production methods and raw materials
- Monitoring of production processes
- Quality control

INSTALLATION

We offer extensive installation services:

- Planning and monitoring of all schedules in the construction phase
- Trained professional personnel for conducting installation work
- Coordination of the teams responsible for removing the old skylights and supporting structures and installing the new system
- Disposal of the old constructions

We provide routine maintenance services for your SHEV systems:

- Survey of the condition of the SHEV systems
- 24-hour hotline
- Immediate notification of our service technicians in the event of an emergency
- Finely woven maintenance network
- Rapid service on-site

STEEL CONSTRUCTIONS WITH MIROTEC

Large glass roofs can no longer support aluminium alone. This is where steel supporting constructions come into play – and we can offer you these as well: Our subsidiary Mirotec, which has its HQ in Wetztingen (Germany), is a well-known European steel-glass construction specialist. Using state-of-the-art technology which makes it possible to create highly complex constructions via CAD, we are able to make your architectural ideas a reality.

In this regard, we attribute great importance to aesthetics, modernity and environmental compatibility which we believe are fundamental requirements of modern building constructions.

Your biggest benefit from the LAMILUX and Mirotec combination: You reduce the number of interfaces you need by one and you hire two experts who have already implemented many projects together. You benefit from synergy effects which you will notice both in terms of time and cost.

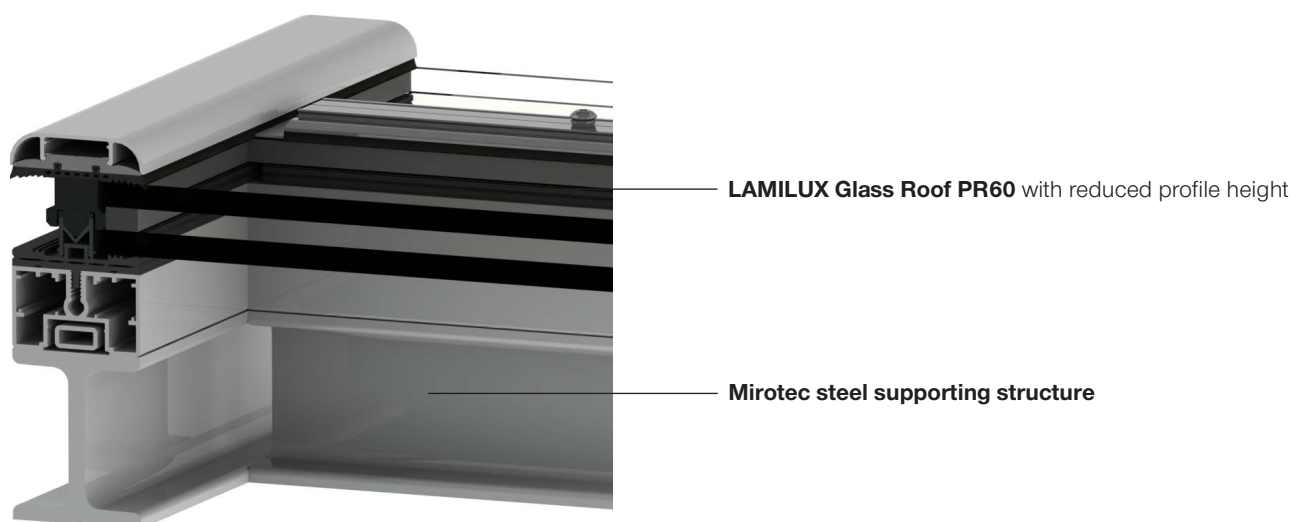



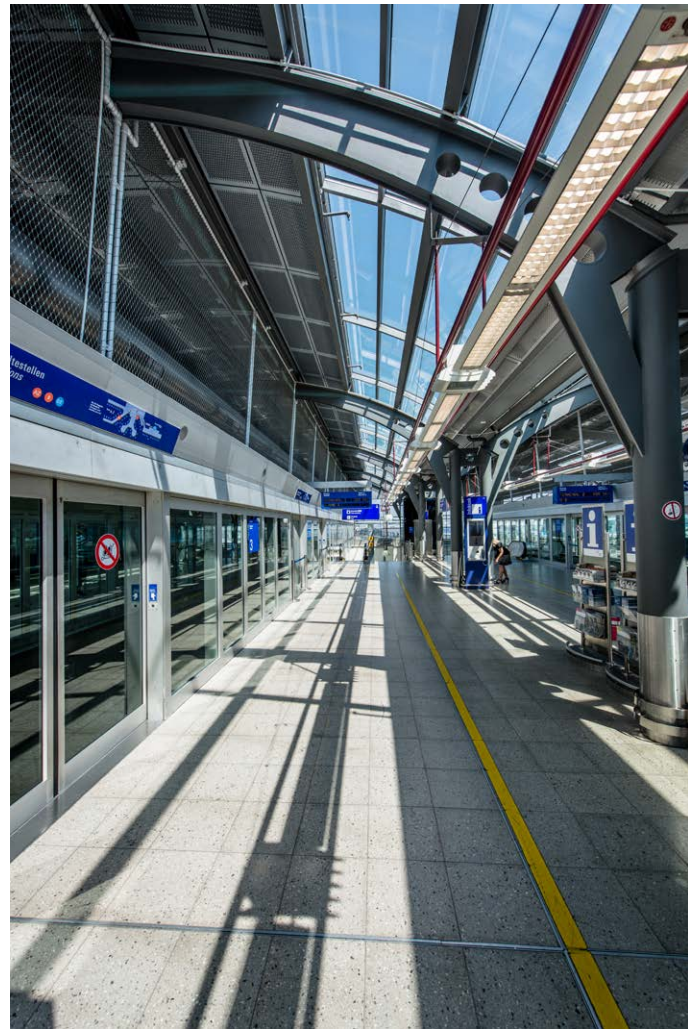

BMW GROUP FIZ, MUNICH

Project:

Special daylight solutions were required for the renovation of this project: The four-storey building is a spatial reorganisation of the product development process. The atrium between the core and outer building is roofed by a special glass construction.

Systems:

- Glass roof construction composed of 60 axes each with 15 panes
- A total of 900 panes, 225 of which have a different format
- Removal of the old and installation of the new glass roof while normal operations continued
- Elevated installation of the glass panes to compensate for any deflection

AIRPORT, FRANKFURT

Project:

Construction of two barrel-shaped glass roofs to complete the station design and for gradual expansion of the station
Continuation of regular station operations during the construction phase

Systems:

- Two LAMILUX Glass Roof PR60 each 12 m wide and 47 m long
- Steel construction made available on-site
- Sun protection glazing for a pleasant climate on the platform
- 16 LAMILUX Smoke Lift Glass Roof PR60 for smoke and heat extraction in the event of a fire
- Fire alarm system underneath the steel construction



HOTEL DON CARLOS, MARBELLA

Project:

Installation of a hipped glass roof above the atrium of the spa resort
Reduction of the energy requirements for lighting and air conditioning

Systems:

- A LAMILUX Glass Roof PR60 with a width of 7.5 m and a length of 13.2 m with a roof inclination of 15°



ZOO, NEUWIED

Project:

New construction of the South America building with a large daylight pyramid
Active building management for the tropical, heated animal enclosure and its residents

Systems:

- A LAMILUX Glass Roof PR60 as a square pyramid with an area of 304 m² with a width and length of 16 m respectively and a roof inclination of 24°
- Installation of eight LAMILUX Smoke Lift Glass Roof PR60, SHEV pneumatic cylinders as well as a wind and rain sensor set



HOTEL VIER JAHRESZEITEN, MUNICH

Project:

Renovation of the glass roof pyramid in the courtyard and above the hotel lobby
 Improvement of the aesthetic qualities of the courtyard
 Erection of a pent roof for removal of the old construction and installation of the new one

Systems:

- A LAMILUX Glass Roof PR60 with a width and length of 12 m and an inclination of 15°
- Two-layer sun protection glazing as well as matt film
- Two LAMILUX Ventilation Flap PR60 for daily aeration and ventilation
- Two inlet flaps for internal cleaning

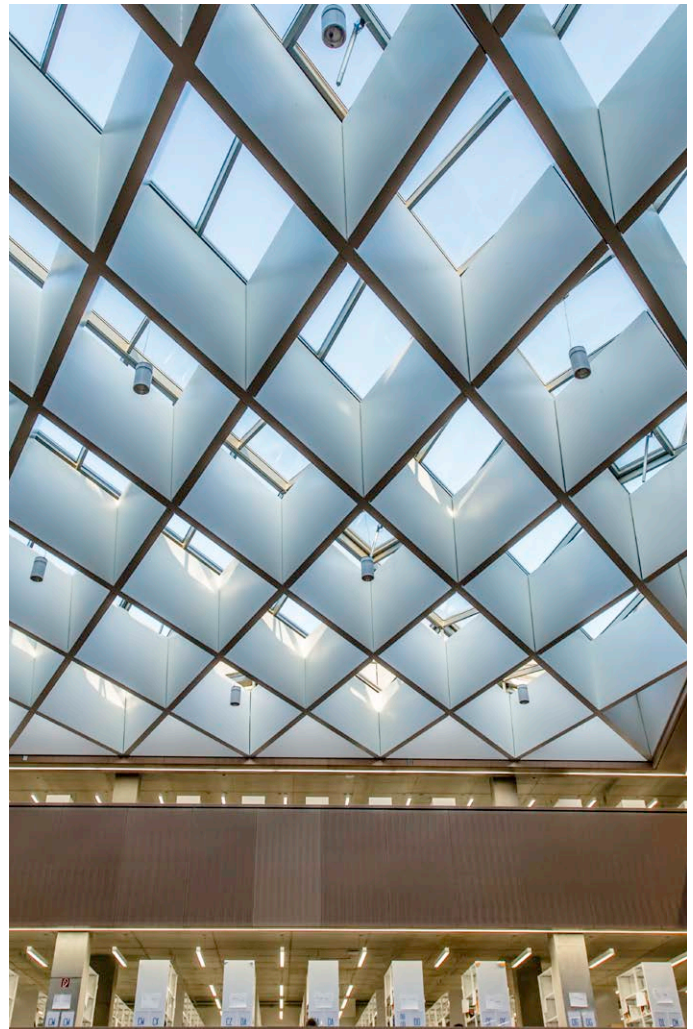

UNIVERSITY LIBRARY, DARMSTADT

Project:

New construction of the library building with a polygonal glass roof structure in the centre of the building
 Reading rooms and open-air areas flooded with plenty of daylight

Systems:

- A LAMILUX Glass Roof PR60 with a surface inclination of 15°
- Six LAMILUX Smoke Lift Glass Roof PR60 with ventilation and SHEV function

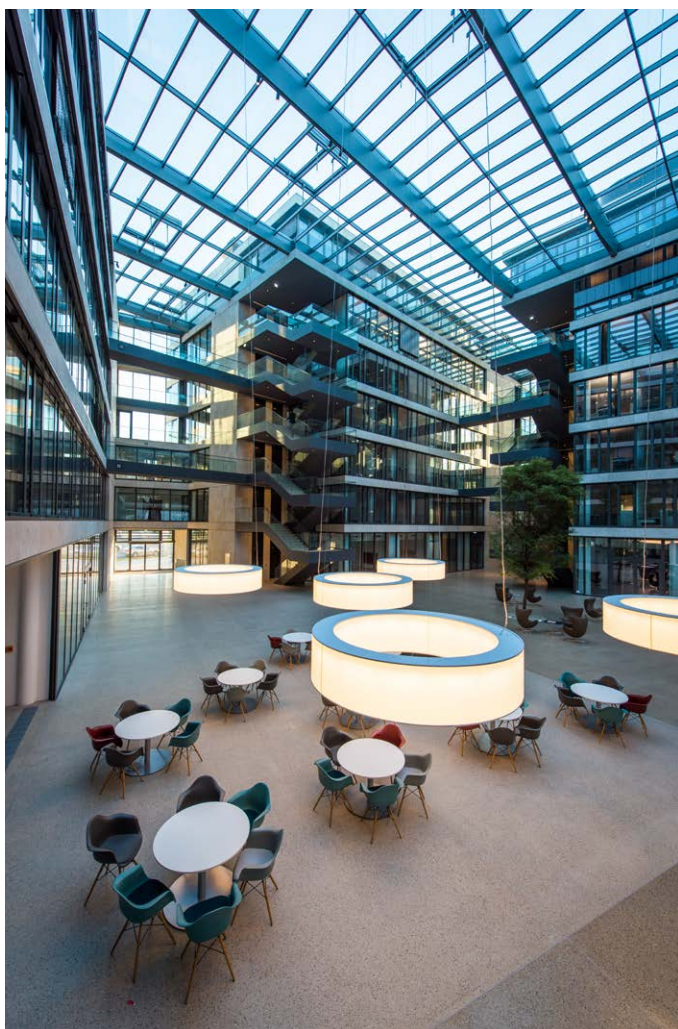

FGS CAMPUS, BONN

Project:

Roofing for the courtyard on an area of 1,700 square metres
Creation of a bright feel-good atmosphere in the building complex with offices, cafés, exhibition areas and a library

Systems:

- Twelve LAMILUX Glass Roof PR60 in ridged roof design and various sizes
- Steel supporting structure made by our subsidiary Mirotec
- Nine LAMILUX Smoke Lift Glass Roof PR60 as double flaps each with an aerodynamic smoke ventilation area of 3.39 m² at a maximum opening angle of 90°



WILLIBALD-GLUCK- GYMNASIUM, NEUMARKT

Project:

New construction of a close to zero-energy school building with two glazed atrium roofs
Considerable use of daylight to implement the energy concept
Night-time cooling and ventilation through the atria

Systems:

- Two LAMILUX Glass Roof PR60 Passivhaus with a width of 13 x 21 m and 13 x 20 m
- Six of the 54 or 60 glass sections fitted with SHEV flap
- Highest Passivhaus classification (pha Advanced Component) as per the Passivhaus standard of the Passivhaus Institute Darmstadt

LAMILUX

VENTILATION FLAP PR60

Bring not only daylight but also fresh air into the building by integrating flap systems into glass roof and façade constructions. The LAMILUX Ventilation Flap PR60 are easy to activate and make a significant contribution to climate optimisation in buildings. This also considerably reduces the energy required for air conditioning units used for cooling. Around 30 percent of energy used to heat and cool buildings can be saved as a result of efficiency optimisation functions in room automation systems.

Our Ventilation Flap PR60 can be integrated in all commercially available mullion-and-transom systems. Its opening angle is continuously adjustable; opening itself is possible by means of various motor variants. The materials used for the ventilation flap are designed for durability.

The flap has a special design: It has the lowest roof upstand on the market and, thanks to the optional structural glazing composite technology, level water drainage. It is also available as a Passivhaus-certified variant in the phB class.

The CE marking – Tested according to DIN EN 14351-1

On the European market, testing of window sashes in line with the product standard DIN EN 14351-1 and CE marking is mandatory. Our flap systems have completed all tests successfully and hold the required certifications:

- Resistance to wind load (Class C5 DIN EN 12210)
- Impermeability to driving rain (Class E 1200 DIN EN 12208)
- Air permeability (Class 4 DIN EN 12207)
- Thermal insulation (U_f -values up to 1.15 W/(m²K) as per ISO 10077-2)



LAMILUX Ventilation Flap PR60 Variant 1

With circumferential cover strip for roof inclinations of between 8° and 75°



LAMILUX Ventilation Flap PR60 Variant 2

With level water drainage for roof inclinations of between 2° and 75°









LAMILUX

SMOKE LIFT GLASS ROOF PR60

Our fitting SHEV unit, the LAMILUX Smoke Lift Glass Roof PR60, can be optimally integrated in the glass roof construction. It also opens safely and reliably in the event of a fire. The SHEV unit can be installed in the LAMILUX Glass Roof PR60 in inclinations of between zero and 90 degrees.

Temperature parameters according to DIN EN 12101-2 and test results

Our NSHEVs reliably open into the SHEV position in less than 60 seconds...

	...and ensure high smoke discharge volumes	Flow rate coefficient C_v of between 0.56 and 0.70; Aerodynamically effective opening area A_w between 0.14 m ² and 4.20 m ²
	...after endurance test – 1,000 times in SHEV position and 10,000 times in ventilation position	RE 50/1000 Ventilation 10,000
	...under snow load	SL 500 to SL 1000
	...down to indoor temperature of -15 °C	T(00) T(-05) T(-15)
	...after exposure to wind suction (up to 1500 N/m ²)	WL 1500
	...when exposed to fire	B300

How your benefit

LAMILUX Smoke Lift Glass Roof PR60

- Flap width and height can be any size up to 2.50 m, covering a maximum flap size of 3.00 m² with real glazing, or up to 3.50 m² with polycarbonate glazing
- Complies with European standard DIN EN 12101-2 for smoke and heat exhaust ventilation systems
- Variable selection of drive systems – pneumatic or 24 Volt electric version
- Perfectly suited for renovations of older glass roof constructions as it can be integrated in systems of other manufacturers



CONTROL TECHNOLOGY – LAMILUX AS A SYSTEM INTEGRATOR

Glass roof constructions provide an ideal platform on which to fit flap systems for smoke and heat exhaust ventilation (SHEV). As a manufacturer and installer of SHEV systems, we have complex trigger and control technologies at our disposal. As a system integrator, we are able to network all movable elements in a building envelope which perform SHEV and air conditioning functions. This is done via control panels. We integrate automation systems in the central building control system.

- Actuation of pneumatic and electric systems as well as drives for ventilation and SHEV units
- Design, installation and commissioning of the signalling sensors, the triggering units and the drives
- Routing of pneumatic and electric lines
- System integrator for third-party systems
- Interface with building control system

Everything for all project phases from a single source

From small control solutions to comprehensive building automation in large facilities, we provide all services in all of the relevant trades from a single source to ensure reliable implementation: From planning and designing the electrical and pneumatic control systems and components to their installation, commissioning and maintenance.

Control with our systems

- Smoke and Heat Exhaust Ventilation Systems
- Flap systems for natural ventilation
- Solar protection and light direction
- Sensor-controlled switching of electric lighting and
- temperature-dependent switching of air conditioning units

...and benefit from intelligent networking of building safety, energy efficiency and building comfort.



SOLUTIONS FOR OPTIMUM STRUCTURAL ATTACHMENT

LAMILUX Glass Roof PR60 is every architect's dream come true with its free design language. Almost any aesthetically appealing and technically challenging glass roof construction can be implemented with this system. The only condition is that Optimum stability and safety even in the structural attachment.

The high quality of the Glass Roof PR60 is therefore not only displayed in high-grade overhead glazing and in profiled cover strips with stainless steel screw joints, but also in the structural attachment. Our system features heat insulated eaves with foil edging and continuous flashing.

The Glass Roof PR60 stands out thanks to its wide range of roof fitting and roof attachment variants and can be customised to accommodate all types of building architecture.

Examples of roof attachment variants:

- Attachment to an insulated concrete upstand
- Attachment to an insulated wooden upstand
- Vertical attachment to a wooden upstand
- Attachment to a steel sheet frame

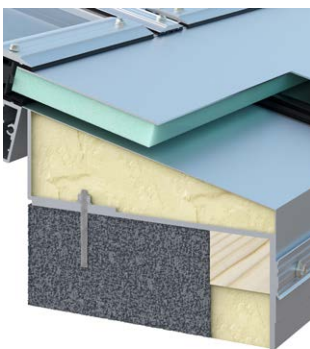

Installation on concrete upstand



Installation on wood upstand



Vertical installation
on wooden upstand

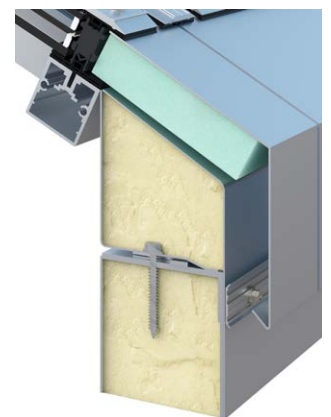

Installation on steel sheet upstand



Accessories

Light intake, thermal protection and sun protection

Building use determines how much daylight provides natural, energy-saving illumination, when solar heat input needs to be limited, and how glare effects can be avoided. We adapt glazing types and sun protection systems to these comfort requirements.

Daylight intake and solar heat input create great potential for channelling energy into buildings and making savings on costs for heating and artificial light. This should not be achieved in an uncontrolled way, but must be regulated and guided by permanent or controllable shade systems.

The new internal shade system, for example, is ideally suited for this purpose: It is installed between the profiles and the motor-driven shading works according to the principle of cross-draught. This means that when the hanging is extended, it is removed from the fabric shaft and, at the same time, the textile lift tape is wound up.

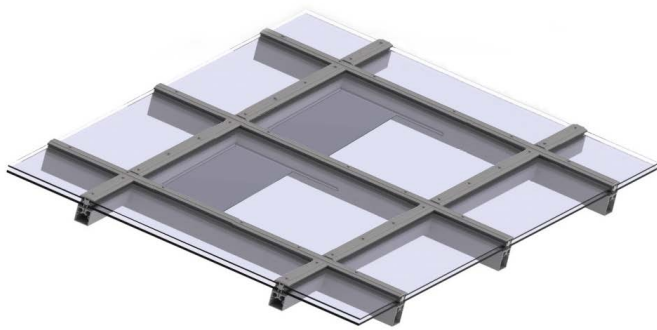

Internal shade system

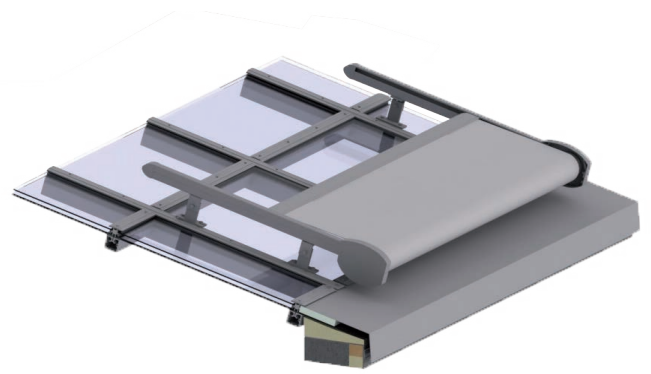

External shade system

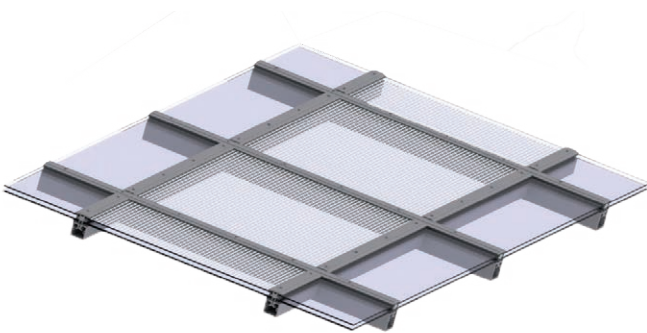

Screen-printed/matt, light-coloured film



Lamella shade

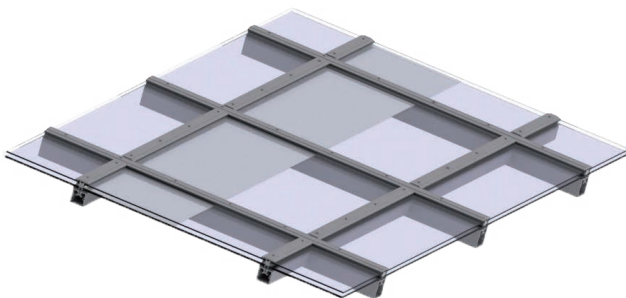

Pane-integrated shade system

Comfort and safety



QUALITY

Functionality in extreme weather events

- Tested watertightness in heavy rain and during storms (impervious to driving rain, in accordance with DIN EN 13830, Class RE1950)
- High resistance to wind loads (2000 Pa as per DIN EN 13830)
- Outstanding airtightness (AE 3000 positive test pressure as per DIN EN 13830)
- Optimised soundproofing and minimised rain noise thanks to special glazing ($R_w = 46$ dB as per EN 10140-2)

Certified quality

- Certification of the factory production control as per DIN EN 1090-3
- Quality management system ISO 9001:2008
- Climate protection and recycling certificates
- Sense of responsibility even in the field of packaging disposal



INNOVATION

LAMILUX Ventilation Flap PR60 with the lowest roof upstand

- Architecturally appealing design with a roof upstand of only 40 mm
- Tested watertightness in heavy rain and during storms (impervious to driving rain, in accordance with DIN EN 12208, Class E1200)
- High resistance to wind loads (wind load class C5 as per DIN EN 12210)

- Excellent air permeability (performance class 4 as per DIN EN 12207)

Daylight elements with continuous life cycle assessment

- EPD: Environmental Product Declaration as per DIN ISO 14025 and EN 15804 (A1-D)



SERVICE

Optimum service

- Unique full service thanks to planning, construction and installation of the glass structure from a single source
- Friendly and competent consultation on-site
- Professional maintenance and servicing

- Optimum planning and safety in all renovation stages thanks to customer-oriented and result-oriented implementation



COMPETENCE

Expertise

- Specialist for overhead glazing types
- Optimally trained and experienced employees, fitters and subcontractors

From a single source

- Made-to-order complete solutions for all daylight, SHEV, ventilation and control technology matters



PROBLEM SOLUTION

LAMILUX Smoke Lift Glass Roof PR60

- Opens reliably in under 60 seconds in the SHEV position and ensures high smoke discharge volumes
- Complies with European standard EN 12101-2 for smoke and heat exhaust ventilation systems
- Perfectly suited for retrofitting to older roof structures as it can be integrated into other systems

LAMILUX Glass Roof Fire Resistance REI30/F30

- Tested and certified fire resistance with the complete system remaining functional for 30 minutes
- Classification as per DIN EN 13501-2 (REI30) and General Technical Approval (abZ) as per DIN 4102-13 (F30)

Optional Passivhaus certification

- First sloped glazing certified to Passivhaus standard in the highest Passivhaus efficiency class (phA advanced component)

LAMILUX
MODULAR GLASS SKYLIGHT MS78





LAMILUX

MODULAR GLASS SKYLIGHT MS78

LAMILUX Modular Glass Skylight MS78 combines the advantages of two proven LAMILUX-systems – LAMILUX Glass Skylight FE and the LAMILUX Glass Roof PR60 and inspires with glass roof innovations. With large areas of light thanks to multi-pane glazing and opening vent, it provides increased daylight incidence in buildings with a width of 3 metres and variable length.

The variable and opening vent integration of the new LAMILUX glass roof ensures high ventilation comfort and offers a uniform appearance of opening vents and fixed elements with concealed integrated drives. Architects and roofers benefit above all from short delivery times thanks to lean and automated processes as well as simple and safe roof integration thanks to the system's own connection technology.

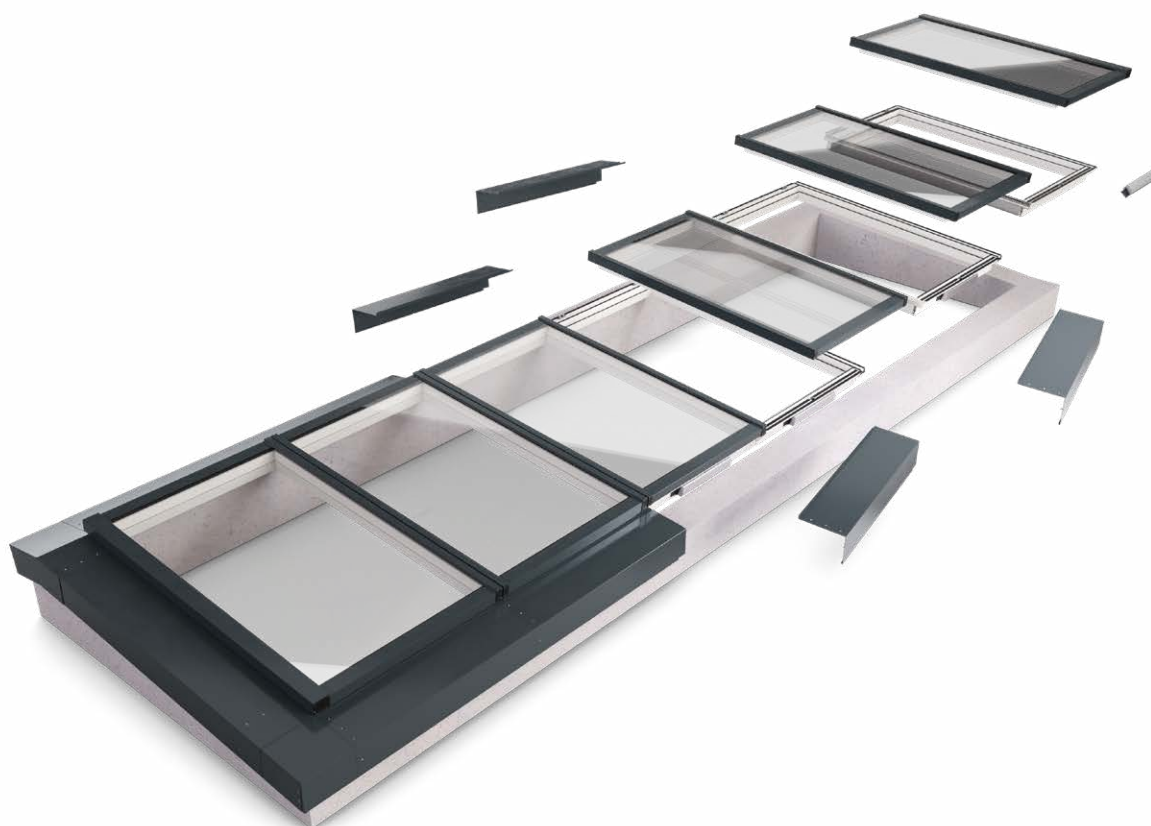



 **ENERGY EFFICIENCY AND SUSTAINABILITY**

Sustainable product terial cycle through single-origin recycling

All-round optimal thermal protection in a compact, thermal bridge-free overall system

Energy cost savings and minimized risk of condensation thanks to kink-free isothermal progression

 **PRODUCT VARIETY AND HIGH-QUALITY STANDARDS**

Uniform appearance of Opening vents and fixed elements thanks to opening vent integration (NFI)

Maximum ventilation area due to unrestricted Opening vent arrangement

High proportion of glass due to module sizes up to 1.30 m x 3.00 m

Full light surface due to Opening vent without clamping frame

 **FUNCTIONALITY AND SAFETY**

Drainage profile offers maximum safety from the first sealing level onwards

Precise installation thanks to V-groove and self-aligning module connection (SAM)

Optimised construction process thanks to complete installation from the roof side in one stage

COMBINES THE ADVANTAGES OF TWO PROVEN SYSTEMS WITH NEW GLASS ROOF INNOVATIONS

**LAMILUX
Glass
Skylight FE**



**LAMILUX
Glass Roof
PR60**

benefit from the advantages of the LAMILUX Glass Skylight FE

- Short delivery time through lean and automated processes
- Best quality standards due to high degree of prefabrication
- Simple and safe roof integration through system-specific connection technology

benefit from the advantages of the LAMILUX Glass Roof PR60

- Large areas of light due to multi-pane glazing
- Proven glass roof drainage with two drainage levels
- High ventilation comfort through variable opening vent integration



OPTIMIZED FOR ASSEMBLY AND BUILDING CONNECTION

Thanks to the V-groove and the self-aligning module connection, a precisely fitting installation of our modules is guaranteed. This enables quick and precise assembly of the modules, optimizing the construction process. The complete assembly can be carried out from the roof side in one stage.

Thanks to innovative load converters, the system can be installed directly on load-bearing surfaces such as concrete, wood and steel without additional profiles to create a stable and secure connection and compensate for tolerances in the substrate. This saves time and costs during installation and makes the system more flexible in terms of subfloor requirements.



Assembly on concrete edging



Assembly on wooden edging



Assembly on steel upstand

LAMILUX GLASS ROOF FIRE RESISTANCE REI 30 AND REI 60

To prevent serious consequences in case of fire, it is important to choose the right protection using a fire resistant window when building a new property or renovating an existing one. Our classified Glass Roofs Fire Resistance with heat and fire resistant glazing prevent the fire from spreading to adjoining parts of the building during the specified period.

The equipment variants of the Glass Roofs Fire Resistance certified according to European fire resistance class REI 30 and REI 60 withstand the fire with tested additional loads for 30min and 60min respectively. The Glass Roof, which is available in larger lengths, does not require any complex support elements and can be installed in roof inclinations from two to 80°.

Design combined with safety! You can adapt the self-supporting construction according to the customer's and aesthetic specifications. In the field of safety, our Glass Roofs Fire Resistance provide resistance to external fire exposure from flying sparks and radiating heat with classification B_{ROOF} (t1) according to DIN EN 13501-5.

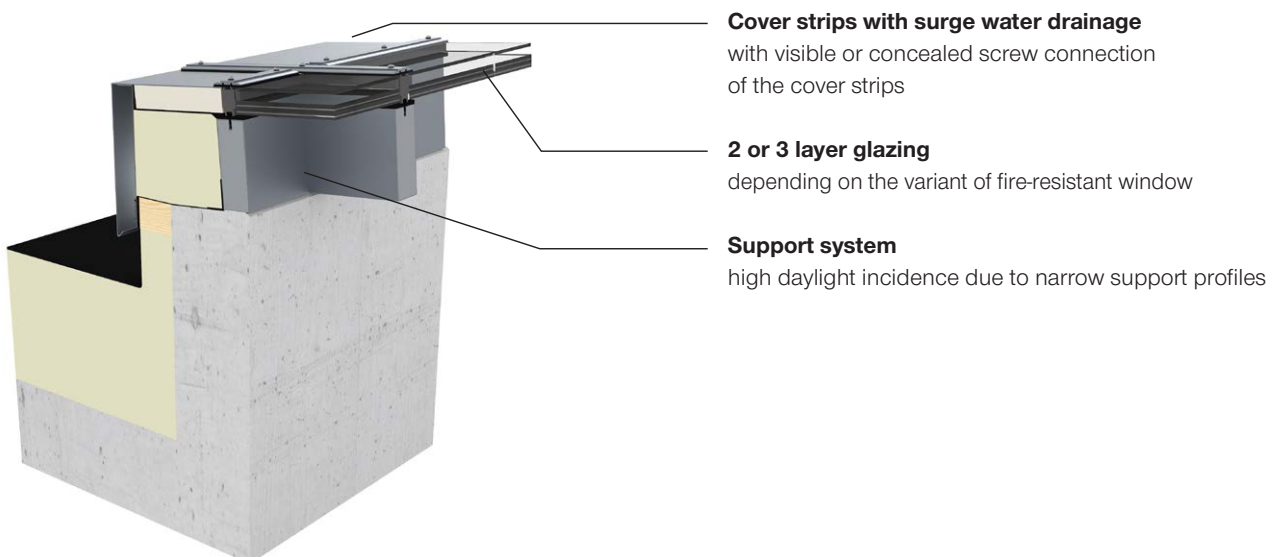



 **OPTIMISED SEALING AND DRAINAGE SYSTEM**

Efficient ventilation of glazing rebates and controlled drainage of water and condensate

Overlapping, multi-layered sealing system, designed without direct joints and a secondary drainage system in the inner sealing layer

Joint-free, continuous drainage level on the mullion/transom

Increase and improvement of the surface temperature on the glass edge and subsequent reduction in risk of condensation

 **PRODUCT VARIETY IN HIGH QUALITY STANDARDS**

Glass Roofs Fire Resistance available in fire resistance classes REI 30 and REI 60 and in various sizes. Also available as Glass Skylight Fire Resistance

German Design Award 2023 in the category „Excellent Product Design - Building and Elements“ for our new Glass Skylight Fire Resistance REI 90

Visible elements of the supporting structure with RAL coatings

Visible or concealed screw connection of the ceiling strips possible

 **SAFETY**

Fire resistance with the functional integrity of the complete system certified to 30 minutes / 60 minutes

Resistance to external fire exposure from flying sparks and radiating heat with classification B_{ROOF} (t1) as per DIN EN 13501-5

Classification according to EN 13501-2

 **ACTIVE ENERGY MANAGEMENT**

Reduction of heat loss in the frame

Optimised building energy balance through improved thermal insulation

Combination of fire protection properties and energy benefits

DESIGN AND COMFORT WITHOUT COMPROMISING ON SAFETY

In the past, fire resistant glass roofs were rather massive. Without compromising on fire protection properties, filigree cover strips and a self-supporting construction now ensure an aesthetically appealing appearance that can hardly be distinguished from conventional LAMILUX Glass Roofs from the outside.

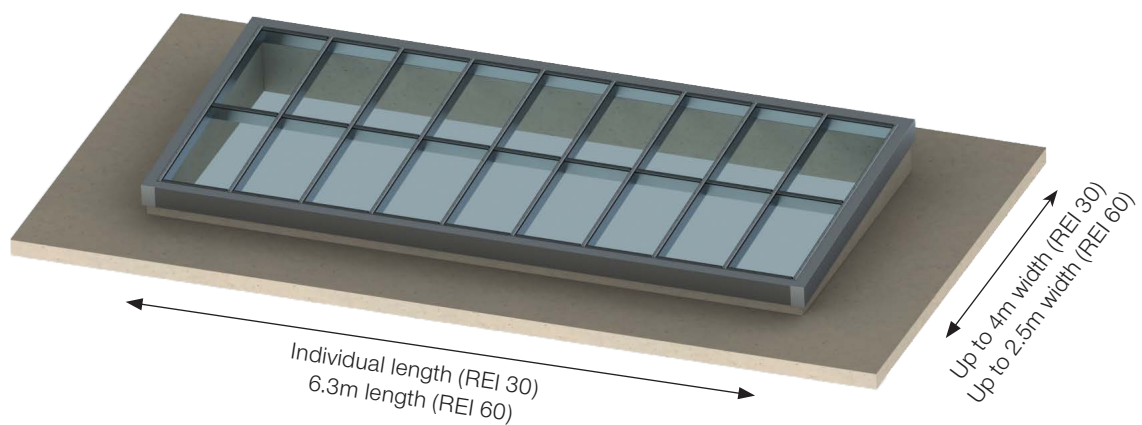

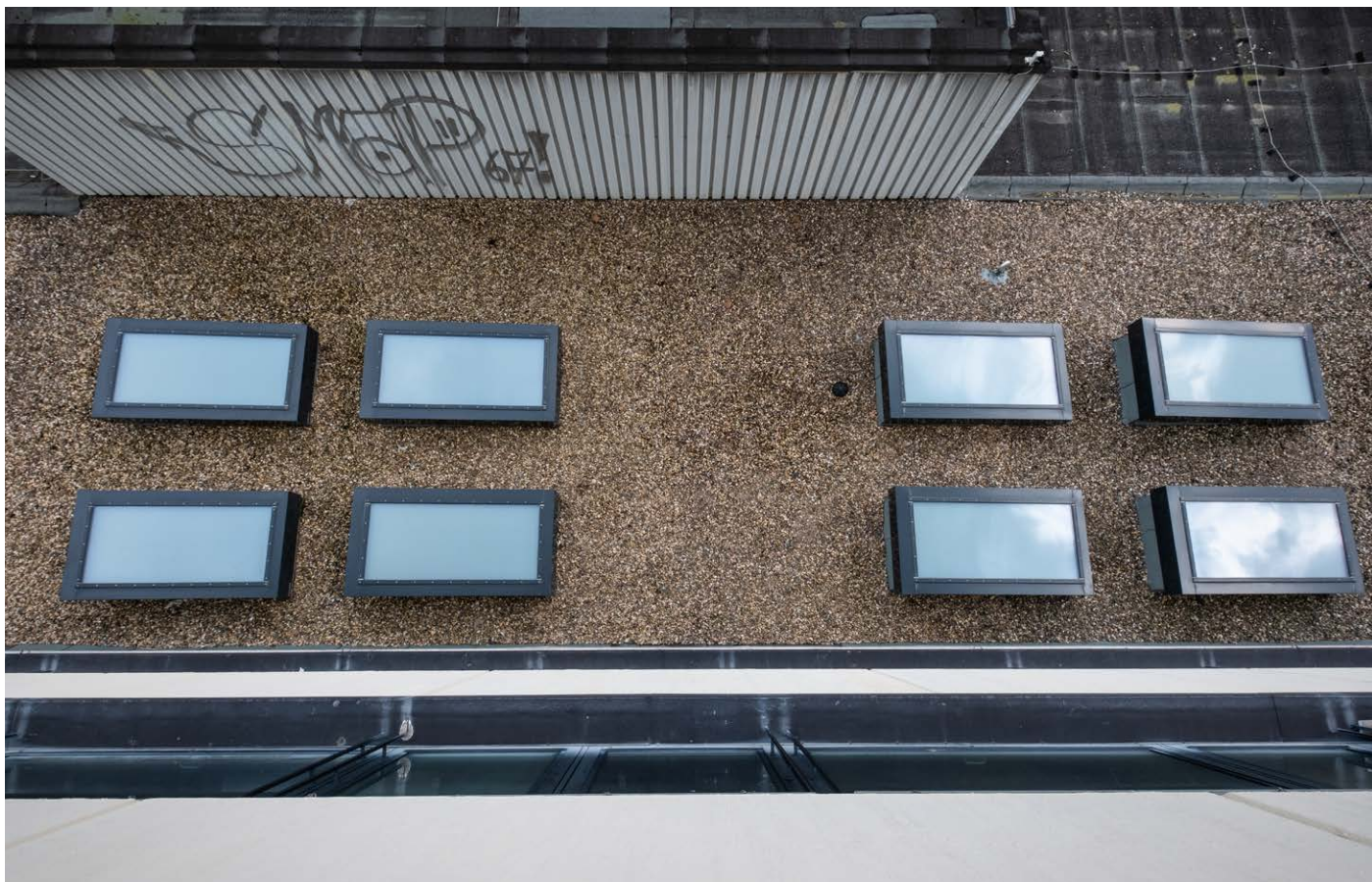

LAMILUX GLASS ROOF FIRE RESISTANCE REI 30

Sieg Sand School in Cologne

Windows with fire resistant glazing are mainly used in larger public buildings where many people can be found, such as educational establishments, cultural facilities or shopping centres, among others.

There, our Glass Roof Fire Resistance REI 30 forms fire barriers and is available in visually appealing designs. With special layers built into the glass panes and materials, this ensures that human lives and property are protected for up to 30 minutes without the fire spreading to adjoining parts of the building.



Scan this to learn more about
LAMILUX skylights!

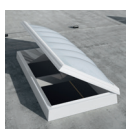

ROOFLIGHT F100 W



GLASS SKYLIGHT F100



GLASS SKYLIGHT FE



GLASS ARCHITECTURE



FLAT ROOF ACCESS HATCH



MIROTEC STEEL CONSTRUCTIONS



CONTINUOUS ROOFLIGHT B/S



RENOVATION



TRANSLUCENT FAÇADE AND ROOF



SMOKE AND HEAT EXHAUST
VENTILATION SYSTEMS



RODA LIGHT AND AIR TECHNOLOGY



MODULAR GLASS SKYLIGHT MS78

The technical data listed in this brochure correspond to the current status at the time of printing and are subject to change. Our technical specifications are based on calculations and supplier specifications, or have been determined by independent testing authorities within the scope of applicable standards.

Thermal transmission coefficients for our plastic glazing were calculated using the finite element method with reference values in accordance with DIN EN 673 for insulated glass. Taking into account practical experience and the specific characteristics of plastic, the temperature difference between the outer surfaces of the material was defined as 15 K. Functional values refer to test specimens and the dimensions used in testing only. We cannot provide any further guarantees of technical values. This particularly applies to changed installation conditions or if dimensions are re-measured on site.



LAMILUX Heinrich Strunz GmbH

Zehstraße 2 · PO Box 1540 · 95111 Rehau · Tel.: +49 (0) 92 83 / 5 95-0 · Fax +49 (0) 92 83 / 5 95-29 0

E-Mail: information@lamilux.de · www.lamilux.com

